

---

# NMIO Technical Bulletin

National Maritime Intelligence-Integration Office

---

OCTOBER 2016 - VOL 11



# Director NMIO View:

Rear Admiral Robert Sharp, USN

As the Director of the National Maritime Intelligence-Integration Office (NMIO), I am pleased to present Volume 11 of NMIO's Technical Bulletin. This is the first volume being published during my tenure at NMIO, and is the perfect introduction to one of our most important annual events - the Global Maritime Forum (GMF).



This Forum will focus on the challenges and opportunities of current and emergent maritime capabilities, while exploring the intersection of emerging technology and policy development. The Technical Bulletin is one of our key vehicles to promote enhanced maritime domain awareness and information sharing. Please enjoy the wonderful and well-written articles in this volume on

topics related to the emerging technological advancements used in the maritime domain and, more importantly, the policy implications of use from a sharing and interoperability perspective.

Science and technology is a fascinating field where research and development opportunities abound, having broad applicability to a range of maritime endeavors. As innovative capabilities are developed for use in the open ocean, the maritime community must consider the resulting policy elements that may create challenges or risks to our mutual security and ability to share and control large quantities of data. Given the rapid transition from prototype to a fielded capability solution, we must develop the necessary policies to ensure consistent, transparent, and predictable deployment of those technologies.

NMIO continues to advance the Global Maritime Community of Interest (GMCOI), and your valued contributions positively affect the safety of the maritime domain. As we continue to innovate, we must remember to partner across the GMCOI in order to successfully maintain safe and secure use of the maritime domain for all. This edition of the NMIO Technical Bulletin highlights efforts to incorporate new capabilities with existing maritime data to advance strategic, operational, and tactical decision making.

I would like to personally thank those authors who invested their valuable time to contribute to this edition of our Technical Bulletin. The articles contained herein capitalize on our relationships with all levels of government, international, industry, and academia partners. I encourage other stakeholders to become more involved in this community publication, by submitting articles to help us broaden the topics and regions covered in this product. I hope you enjoy these articles on technological advancements used to counter illicit maritime activity and the policy implications from a sharing and interoperability perspective. I look forward to continuing to work collaboratively with the community of interest to address challenges and opportunities of common concern!



## NMIO Technical Bulletin

Volume 11, October 2016

Editor In Chief: Ms. Mekisha Marshall, Science and Technology Advisor, NMIO

Email: mmarshall@nmic.navy.mil

Chief, Strategic Engagement, Mr. Chuck Elder; NMIO

Phone: 301-669-2560

Email: celder@nmic.navy.mil

Production: ONI Media Services

Address: 4251 Suitland Road

Washington, DC 20395

**Editor Note:** The USS Zumwalt (DDG 1000) is a prime example of operationalizing a cluster of emerging technologies for new maritime capabilities.

**Correspondence:** Ms. Mekisha Marshall

**Contributions welcome:** We welcome contributions from all Global Maritime Community of Interest stakeholders, both domestic and international. In submitting your article, please highlight who you are, what you are doing, why you are doing it, and the potential impacts of your work. Please limit your article to approximately one to two pages including graphics. Articles may be edited for space or clarity.

**Cover Image:** 16107-N-CE233-184 Chesapeake Bay, Maryland. (October 17, 2016) USS Zumwalt (DDG 1000) approaches the Governor William Preston Lane Memorial Bridge, also known as the Chesapeake Bay Bridge, as the ship travels to its new home port of San Diego, California. Zumwalt was commissioned in Baltimore, Maryland, October 15 and is the first in a three-ship class of the Navy's newest, most technologically advanced multi-mission guided-missile destroyers. (U.S. Navy photo by Liz Wolter/Released)

# Table of Contents

<b>Operational Aspects of Maritime Domain Awareness</b> .....	<b>4</b>
John Mittleman, PhD, Naval Center for Space Technology, Naval Research Laboratory	
<b>Technology Recommendations for Ocean Protection</b> .....	<b>7</b>
Johan Bergenås and Ariella Knight, Stimson	
<b>Space Cooperation Among Order-Building Powers</b> .....	<b>10</b>
Scott Pace, Elliot School of International Affairs, George Washington University	
<b>Integrated Communication Extension Capability (ICE-CAP)</b> .....	<b>14</b>
Peter J. Yoo, SPAWAR Systems Pacific	
<b>Project Interoperability in Puget Sound (PIPS)</b> .....	<b>17</b>
The Center for Collaborative Systems for Security, Safety and Regional Resilience (CoSSaR), Applied Physics Laboratory, University of Washington	
<b>Towards Real-Time Under-Ice Acoustic Navigation at Mesoscale Ranges</b> .....	<b>20</b>
Sarah E. Webster, Lee E. Freitag, Craig M. Lee, and Jason I. Gobat, Department of Ocean Physics, Applied Physics Laboratory, University of Washington	

Disclaimer: The views and opinions expressed in these articles are those of the authors and do not necessarily reflect the official policy or position of any agency of the U.S. government. Assumptions made within the analysis are not reflective of the position of any U.S. government entity.

# OPERATIONAL ASPECTS OF MARITIME DOMAIN AWARENESS

John Mittleman, PhD, Naval Center for Space Technology, Naval Research Laboratory

In this issue of the National Maritime Intelligence-Integration Office's Technical Bulletin, we discuss trends in Maritime Domain Awareness, and how policy and technology interact in developing a level of understanding that serves as the foundation for command.

This article starts by briefly tracing the roots of our cooperation on the use of space for MDA and reviewing important documents in the development of U.S. doctrine. From there, it concentrates on the very challenging concept of MDA as "the effective understanding" of maritime activity and the need that this generates for inter-agency, or inter-ministerial information sharing. Finally, it highlights a few recent developments that will influence the future of our use of space for MDA.

## A BRIEF REVIEW:

Maritime Domain Awareness was first defined in U.S. policy, in a formal sense, in our 2004 National Security Presidential Directive-41 (NSPD), "Maritime Security Policy," and reiterated in subsequent policy documents related to MDA: "Maritime Domain Awareness (MDA) is the effective understanding of anything associated with the global maritime domain that could impact the security, safety, economy, or environment of the United States." This definition, with word changes appropriate to other countries and communities, has been accepted around the world. Yet, it poses a remarkably challenging problem: what, exactly, is "effective understanding," and how do we attain this lofty goal?

In 2005 the NSPD was translated into concrete implementation and policy documents such as the "National Strategy for Maritime Security" (NSMS) and one of its component plans, the "National Plan to Achieve Maritime Domain Awareness" (NPAMDA). Over the course of the eight years that followed release of the NPAMDA, each U.S. Department and Agency that had a serious stake in MDA, most notably Department of Defense, Department of Homeland Security, and Department of Transportation, worked on plans to implement steps to achieve greater MDA. In 2013, the White House published a new National Maritime Domain Awareness Plan to replace and merge the NPAMDA and the Global Maritime Intelligence Integration (GMII) Plan under the NSMS. In the face of all these updates and changes, however, the original definition of MDA, embracing the concept of "effective understanding," has stood the test of time

unchanged. What, then, is "effective understanding," and how is it created?

## EFFECTIVE UNDERSTANDING:

We consider "effective understanding" as it appears in three domains: tactical, operational, and strategic. In each, there are distinct policy, technology, and budgetary implications.

### Tactical Understanding.

At the tactical level, a central issue for mission success is directing an asset and its related personnel to the right location at the right time, with the right capabilities and resources, to identify and, if required, intercept certain activities, such as illegal fishing, narcotics trafficking, or transporting illegal migrants. To the analyst, this means *maximizing the probability of encounter* with those engaged in, or associated with, harmful, hostile, or unlawful activities. To do this, the tactical Commander needs to know the current locations of all vessels in the area, commonly presented in a "common operational picture" or "recognized maritime picture."

When first presented with the AIS capability, Admiral Ulrich looked at all the vessels and asked the question: "which **one** am I interested in?" The technologies to detect and geo-locate vessels, large and small, is a major part of maritime domain awareness, but even a complete picture of every vessel at sea doesn't always aid in making decisions. This clearly articulated the difference between data, as presented by AIS, and knowledge that the Admiral as a consumer could apply to his decision making. This involves analysis, or risk assessment and threat evaluation, often performed at the operational level, and passed to the tactical level to guide at-sea or air patrols. Policy enters the equation even at the tactical level, however. As an example, evidence collected at sea may have to be handled in accordance with strict "chain of custody" requirements to ensure admissibility in court, or photographic and navigational equipment on maritime patrol aircraft may have to be certified in order to produce legally admissible evidence to support a prosecution of illegal activity.

### Operational Understanding.

At the operational level, a central issue is *minimizing the expected cost of mission success*. Operational analysis, often performed at Fleet headquarters,

informs Command by sorting all known vessels, and identifying for each whether the observed activity is legal or illegal, threatening or benign, within the Commander's area of responsibility or not, and so on. It is this additional information, not just vessel positions, or "dots on a map," that allows decision-makers to prioritize the use of tactical assets. It is generally at the operational level that "vessels of interest" are designated and prioritized, based on their activity, location, history, affiliations, and other information, as well as the Commander's authorities, the availability of assets and resources, safety considerations, geopolitical context, and strategic objectives.

Mission success is often achieved when an arrest is made or a vessel is seized. At the operational level, costs are minimized when those tactical forces are sent directly to vessels of interest rather than having those at-sea forces burn fuel and time blindly searching for something that looks suspicious. Policy success is reflected at the operational level in the Maritime Commander's authorities, adherence to the Rules of Engagement, in development of available Courses of Action, and effective use of the assets and resources available. It is also reflected in our ability to effectively share information among the agencies and ministries authorized to receive it. In the United States, for example, military, law enforcement, and intelligence agencies have different authorities, defined in the U.S. Code and associated Federal Regulations, to collect and hold different types of information. That can be a problem if, for example, a risk assessment model requires a combination of those kinds of information to arrive at "effective understanding."

## Strategic Understanding

At the strategic level, the most important issues are general force structure and resource allocation to effectively achieve national policy goals, with the objectives of *safeguarding the freedom of the seas, deterring conflict and coercion, and promoting adherence to international law and standards.*<sup>1</sup> Examples of such national policy goals include: *ensuring freedom of navigation and the free flow of trade; ensuring responsible access to fisheries and mineral resources; and, preventing the deliberate misuse of the maritime domain to commit hostile, harmful, or unlawful acts.*

At the strategic level, the use of space is particularly well suited to developing an overall understanding of the level and distribution of activity within an area of responsibility. Even well offshore, beyond the horizon for land-locked decision-makers, and too far to sea for regular maritime patrols, the view from space gives us a clear picture of how many vessels there are and where they are located. Perhaps they're transiting, perhaps they're fishing (with or without proper licenses), or perhaps they're illegally moving drugs, weapons or people.

The patterns of maritime activity, even general trends such as the number of vessels in a nation's Exclusive Economic Zone (EEZ), are important strategic indicators that affect every country's control of mineral and living marine resources located within their respective EEZs. Understanding such activity to the maximum extent possible informs policy and budget deliberations to build, train, equip, and maintain the resources required to achieve strategic goals, such as *ensuring sovereign control of national waters and promoting regional stability.*

## NEW DEVELOPMENTS:

Keeping in mind that MDA involves the *effective understanding* of maritime activity, what new trends and development should we know about?

On the technology side, the commercial sector is engaged in two major areas of considerable interest. The first is creating and collecting new and diverse sources of data, including a remarkable rush toward building and launching small satellites with significant Earth observation capabilities. The second is Big Data analytics, including machine learning, or "deep learning," that captured the world's attention in March 2016 when AlphaGo defeated the reigning world master of the complex game "Go" in four out of five games. Governments are facing difficulties in keeping up with either of these areas of development, often leaving the development of policy lagging far behind the technology available to us.

"Smart phone technology" is a term commonly used to refer to the miniaturization of hardware that performs what used to take a room full of computers. Smart phone technology is present in space, in every cubesat on orbit. For policy makers, the presence, development, and increasing availability of such technology presents some very difficult questions, most of which are beyond the scope of this paper. For example, increasing availability of new commercial capabilities in space will affect national security, as we know it today, in both positive and negative ways. Earth observation capabilities that were once the domain of major powers and their "spy satellites" are now available to the world. Zoom in on Google Earth and you will see your car in the driveway. If there is a profit incentive, analytic programs using imagery from these satellites will be able to detect when your car was moved and when it returned. Commercial satellites now produce imagery with sub-meter resolution and daily revisit times, challenging policy makers to keep pace.

In the world of Automatic Identification Systems (AIS), tracking the location and movement of ships, which made its debut in space in 2008, more than 100 satellites with AIS receivers are scheduled for launch within the next two years. Many of these satellites will carry software-defined radios instead

of dedicated AIS receivers; this means that a broad range of maritime broadcasts and communications will be available for detection by commercial satellites. Again, what was once the domain of national assets is moving into the commercial world, and if these technologies make money, they will challenge policy-makers and regulators to keep pace.

Imagery and AIS are now commodities on today's market, available to anyone with a credit card. Data is essential, but the value-added products are now becoming the analyses of data, rather than collection of the data itself. Like hardware in space, analysis is caught up in the modern world of innovation. "Big Data" analytics extends into maritime domain awareness, and here too, the commercial world may well be ahead of governments. There's a good reason for this: being very informed can make you very rich very quickly. When the first AIS satellite was launched in 2008, the world of futures trading in commodities changed dramatically. For the first time it became possible to track ships everywhere on Earth, and to be able to predict when they would arrive, with their cargo, at their destination. Delays would affect the price of commodities contained in those cargoes, and knowing about that, before anyone else, could make a commodities trader rich. The nexus of big data analytics and small satellites is clear: Silicon Valley money is funding significant ventures into space. They will collect massive amounts of data, the grist for analytics that might make smart investors wealthy.

#### **CLOSING THOUGHTS:**

There are maritime security implications for all of these trends. The abundance of satellites and other assets

with vessel detection capabilities means that we will know about more ships at sea than ever before; however, so will our competitors, criminals, and enemies. This will change the way we operate at sea. It has the potential to make law enforcement, disaster relief, and maritime safety operations more effective, but it might also introduce new military vulnerabilities and new ways for clever adversaries to exploit their own improved maritime domain awareness. From an operational point of view, we should take the next step in building our shared foundation of knowledge and experience by participating together in operations, exercises, and demonstrations that involve MDA, and the use of space for MDA, in support of operations, while working together to seek to mitigate those potential vulnerabilities created by the rapid expansion and dissemination of such capabilities to potential nefarious actors.

It can also be argued that we would benefit by continuing to develop and institutionalize more extensive MDA data sharing within the U.S. government and with our partner nations. Because maritime activity is traditionally often intentionally convoluted and opaque, for either commercial or military advantage, it is time for us to find creative minds to address the problem of protecting sensitive information while allowing analytic processes to access the full range of data available, across the government, commercial, and private sectors. Nothing short of developing a marriage between technology and policy will make sense of maritime activity, or ensure that together we will be able to successfully operate in an ever more challenging maritime domain.

---

<sup>1</sup> "Asia Pacific Maritime Security Strategy, DoD, 2015

# TECHNOLOGY RECOMMENDATIONS FOR OCEAN PROTECTION

Johan Bergenas; Ariella Knight, Stimson

In 2010, governments around the world agreed to protect 10 percent of the world's oceans by 2020<sup>1</sup>. Innovative and integrated technological solutions are critical to amplify, accelerate and strengthen the chance to achieve this goal. Today, many unique technologies have arisen to meet the challenge of illegal fishing and safeguarding marine protected areas (MPA) — from satellite technology and “smart” buoys, to unmanned surface vessels and aerial vehicles (drones). Yet, despite much energy expended by many stakeholders focused on creating technology to combat crimes on the seas, there are some key policy gaps related to this burgeoning requirement that, if addressed, would help propel its real and immediate impact on ocean protection. The Stimson Center offers the following technology recommendations to kick-start the conversation.

## TECHNOLOGY RECOMMENDATIONS

### **Everyone is Innovating, but Few are Integrating**

There is no shortage of technological solutions to enforce the maritime domain. Marine enforcement technology for maritime domain awareness, monitoring, control and surveillance, and conservation purposes more broadly has exploded over the last few decades. So much so, in fact, that the technology itself is outpacing our ability to successfully integrate it into MPA enforcement systems. The gap is not one of technology innovation, but rather of integration. In the years to come, the true capability enabler will be to integrate satellite data with mobile technology, unmanned systems, radars, enforcement buoys, and the like to protect a given MPA. As such, the guiding principle is innovation through integration and finding new value for what already exists.

### **Surveillance is not Deterrence**

Deterrence, the act of preventing a particular act or behavior from happening, is critical to the success of any enforcement system. For deterrence to work, it requires a number of ingredients, including defined rules of law, tools for monitoring lawbreakers, and credible threats of detection, interception, and prosecution.

The conservation and development communities have long struggled with implementing effective deterrence to protect MPAs, often citing operating environments with low capacity and high corruption as key challenges. However, the main problem is not that of the operating environment, it is a misunderstanding of the tools needed for successful deterrence. Surveillance technology — the category into which most MPA enforcement technology falls, and including satellite imagery, acoustic sensors, and onboard observation technology — does not alone create deterrence. Such capabilities must be accompanied with enforcement technology — tools for interception and prosecution — to effectively deter criminals.

### **Work With What You've Got, not With What You Want**

Technology is only as good as its user, a fact on display in many MPA enforcement technology projects that have tried, and failed, to implement advanced technology for oceans protection. All too often, these technology projects fail to evaluate the existing technological capabilities of a given MPA enforcement system which results in the transmission of technology ill-suited to the realities on the ground.

Instead of deploying the most advanced technological solutions — underwater drones, high definition satellite imagery, and top of the line aircraft — to protect MPAs, capacity builders must engage in bottom-up approaches that meet users where they are, technologically speaking.

For an MPA with limited resources and personnel, the first step to increase the capacity of personnel to enforce the MPA could be a simple mobile app to download on their cell phones into which they can track their patrols, sightings of unregistered vessels, and fish population data, for example. While simpler technology than drones and radars, customized solutions that build on existing levels of capacity lay the groundwork for robust technological systems, without requiring huge front-loaded investments of resources or training for the personnel tasked with enforcing laws designed to protect the MPAs. “Low tech,” bottom-up technology holds the key to gradually

<sup>1</sup> Matthew Knight, “U.N. Agrees 2020 Biodiversity Targets,” October 29, 2010, <http://www.cnn.com/2010/WORLD/asiapcf/10/29/un.biodiversity.summit.conclusion/>, accessed October 3, 2016.

and sustainably building capacity from the ground up to protect MPAs.

### **Find Honest Technology Brokers**

The world is seemingly on the precipice of a new era of safeguarding MPAs and combating illegal fishing. This era, however, will consist of a long journey to reach our goals for oceans protection and MPA enforcement. Yet too many technology projects are led or influenced by short-term support dictated by election cycles, donor support, or private sector companies with outdated business models. Technology plans are often designed for short-term fixes instead of longer term solutions without interoperability in mind. Part of the solution to this challenge is to identify professionals who understand sensor fusion and longer term technology integration. Such professionals exist at universities around the world and are excellent, honest technology brokers when designing and deploying technology projects that can outlive their makers.

### **Technology Needs to be Multi-use**

To avoid duplication of efforts and be successfully integrated into the existing enforcement systems of a given country, technology for MPA enforcement stand the best chance for successful adaptation and integration when they are able to be used for multiple purposes. Multi-use technology saves resources and increases partnerships and buy-in from adjacent communities. In countries suffering from piracy or human trafficking and drug smuggling operations in the maritime domain, technology that combats illegal fishing must also be connected to and used for combating such additional threats. In those enforcement buoys gathering meteorological data, they can double as observation buoys to gather and report information on water temperature. Technology that can be customized to serve multiple uses is much more valuable to end users (especially those with limited resources to invest in such projects) than “silver bullet” technology that is designed to do only one specific task.

### **Drawing the Wrong Conclusion from “Growing Pains”**

Some technology projects in the illegal fishing world have experienced growing pains. In one example, a partnership between NGOs, the military community, and the private sector formed to implement a high technology solution to combat both illegal fishing and maritime drug trafficking in a remote MPA. It was a pioneer in both its innovative partnership structure and in its technological design. Initially lauded as a success, the project

experienced some technological difficulties (likely due to a combination of its remote location, a new partnership with unfamiliar actors and the fact that it is truly a prototype technology for what it is being asked to do). Instead of discussing the challenges facing this project openly, however, some in the oceans community spoke of its failure as an open secret from which there is nothing to be learned. Yet within such struggles are important lessons to be learned. In the technology world, these attempts would be called prototyping or a step toward success, in which overcoming hardships is expected. Relatively new to technology, however, the oceans community is struggling to come to the right conclusions about their technology challenges, and is missing opportunities to learn and share lessons learned from them.

The project in the above example itself holds interesting information for future technology projects. First of all, the partnership between private and public sector bodies appears to have been a success. The same goes for that between the conservation and military communities. These partnerships are monumental for an issue on which progress, as discussed in the policy recommendations above, is stymied by artificial silos and a “once burned twice shy” attitude about working across sectors.

Second, the desire for immediate success of MPA enforcement technology projects often hinders the ability of the oceans community to draw the right conclusions about successes or failures, and slows down the institutional learning process. In the above example, the project shows a successful understanding of the need for cross-sector partnerships and multi-use, customized technology. This story needs to be heard even when the technology fails or is temporarily struggling. And it will be as the consortium is aiming to scale the project beyond its initial MPA.

## **AN OPPORTUNITY FOR ADVANCING THE OCEANS SECURITY AGENDA**

These six recommendations are part of an ongoing and growing body of work at Stimson, which is focused on advancing the conversation on the profound linkages between environmental challenges and U.S. and global security — what we call “natural security.”

New voices, ideas and partnerships within and between the environmental and security communities are needed to defeat the sophisticated, networked and sometimes militarized groups perpetrating crimes against the environment — on sea and land. In order for that to happen, both the environmental and



security communities need to learn to speak each other's languages, identify common ground in the fight against environmental crimes and commit to working in concert toward mutually beneficial outcomes.

To that end, this fall, we will launch a new initiative at Stimson called the Natural Security Forum, featuring a wide range of research, analysis and pragmatic programming, including a video and podcast series with some of the most prominent military and security voices around the world on these issues. Preview [www.NaturalSecurityForum.org](http://www.NaturalSecurityForum.org) to get a feel for this initiative, which is a growing consortium of organizations and individuals.

Additionally, in response to the recommendations above and in recognition of the limited availability of clear and organized information on existing and emerging technologies, the Stimson Center, in partnership with National Geographic's Pristine Seas project, has launched a new website, "Secure Our Oceans." The website will be both a 'one-stop-shop' for basic information about existing MPA enforcement technologies as well as a source for inspiration and storytelling about how technology is currently being used to safeguard MPAs around the world.

This website helps countries, multilateral organizations and NGOs find the right technology to protect marine parks and combat illegal fishing. Visit [www.secureoceans.org](http://www.secureoceans.org) and follow us on twitter at [@secureoceans](https://twitter.com/secureoceans).

### About the Authors

Johan Bergenas is a Senior Associate and Director of the Partnerships in Security and

Development Program. One of Bergenas' current primary focuses is "natural security" — the interlinkages between environmental challenges and U.S. national and global security — as well as on technology and public-private sector partnerships. His background cuts across a wide range of transnational security challenges - from WMD proliferation to terrorism and transnational organized crime. Bergenas' work has been published in the New York Times, the Washington Post, Politico, Foreign Affairs, and Foreign Policy. Prior to joining Stimson, Bergenas worked for the Monterey Institute of International Studies and Oxfam America. He has also been a reporter and a freelance journalist for numerous publications, covering a wide range of international and U.S. domestic issues. He holds an honors M.A. degree from the School of Foreign Service at Georgetown University and an honors B.A. degree from the University of Iowa.

Ariella Knight is a researcher with the Partnerships in Security and Development program at Stimson. She leads a wide range of research work focused on natural security and coordinates the program's technology efforts, particularly focused on developing regions. Before joining Stimson, Ariella worked in monitoring, evaluation and learning at the Institute for Inclusive Security and in technology capacity building at the OMNI Institute. She is a candidate for an M.S. from the School of Foreign Service at Georgetown University and holds a B.A. from Colorado College. She has co-authored articles in World Politics Review, the SAIS Journal of International Affairs and the International Relations and Security Network.

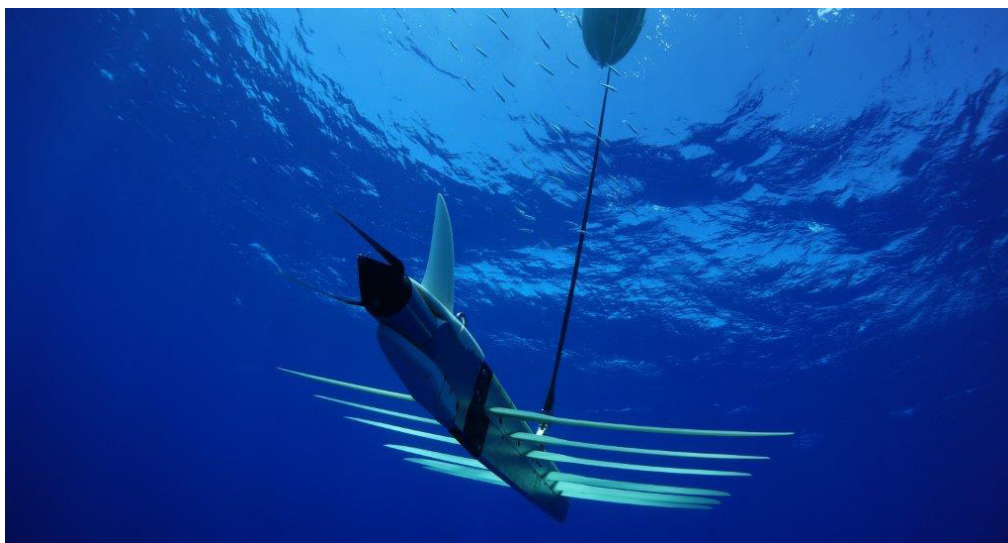

The Wave Glider® by Liquid Robotics® is a hybrid wave and solar powered unmanned surface vehicle designed to help protect exclusive economic zones and marine protected areas from illegal fishing, perform environmental science research and monitoring, and serve the defense market with a variety of applications - all while being powered only by mother nature.

# SPACE COOPERATION AMONG ORDER-BUILDING POWERS

Scott Pace, Elliot School of International Affairs, George Washington University

## INTRODUCING THE SECOND SPACE AGE

The first age of space development, characterized by the race to the Moon and the first explorations of the solar system, is over. Space is no longer a military sanctuary, either technically or politically. Space-based national security systems have emerged into more routine, if not open, usage from the cloak of their nuclear and intelligence origins. The main competitor to the United States in space is no longer the Soviet Union, but other market economies, rogue states such as Iran and North Korea, and increasingly capable Russian and Chinese military forces. The familiar Cold War fault lines have given way to the forces of economic globalization, disorder, and regional hegemony, leading to new risks from the proliferation of advanced technologies and space capabilities.

Civil space exploration and science are also having difficulties in ways that have harmed U.S. international relations. Traditional space partners in Europe and Japan, as well as potential emerging partners (e.g., India, South Korea) have been alienated by U.S. abandonment of the Moon as a focus for international human space exploration. This has been exacerbated by the failure to attract significant international interest in human missions to an asteroid or Mars. The United States abrogated launch commitments to its partners on the International Space Station (ISS) and is currently experiencing the longest gap in U.S. human spaceflight capability since the Carter Administration in the late 1970s.

Recently, Japan has played an important and welcomed role in helping change the direction of international space cooperation with its decision to join the United States in extending the operation of the ISS through 2024. The significance of this step is not just that valuable scientific work will continue or that U.S. and Japanese astronauts will continue to work together. Rather, the renewal of Japan's support for the ISS represents an evolution in strategic, security, and economic relations between the two countries as leaders in the Asia-Pacific region. Japanese participation in the ISS allows for mutual growth in space activities, as the United States and Japan have done with ballistic missile defense, space situational awareness, and maritime domain awareness. It also lays the foundation for further development of Japan's space capabilities to conduct missions to the Moon and beyond. The US-Japan alliance is at a new frontier of growth that has implications beyond just space and the Asia-Pacific region.

Russian and Chinese counterspace capabilities, including ground-based anti-satellite (ASAT) weapons and in-space rendezvous and proximity demonstrations, seem to be part of broader national strategies to unilaterally advance regional hegemonic ambitions - contrary to international law and the wishes of their neighbors. Debates over dual-use capabilities such as launch vehicles, remote sensing, and satellite

navigation, reflect challenges created by globalization and technical changes. These challenges are especially difficult for traditional government bureaucracies to keep up with, creating new economic and security risks. Modern military capabilities are increasingly reliant on having competitive and innovative commercial capabilities. Dual-use space capabilities are increasingly indistinguishable from many military space capabilities.

By their actions, spacefaring powers such as the United States, Japan, Europe, and others have great potential to shape the international environment for space commerce and therefore their military space capabilities. In order to do so, the national security and economic policy-makers need to see space as another, routine, aspect of national power. In turn, we need to look beyond national or even intergovernmental space agencies to take a "whole of government" approach to space issues. This means getting beyond just "interagency" and "intergovernmental" cooperation, but crafting and coordinating strategies with industry and nongovernmental organizations. For governments, it means learning to work in unfamiliar institutions, with new partners, and becoming fluent in unfamiliar languages of business and market-driven technologies. It also means deciding what space capabilities and expertise can and should remain domestic and where alliances and cooperation with other foreign sources make sense.

## GEOPOLITICAL CHALLENGES FOR THE SECOND SPACE AGE

I have written in the past about policy conflicts over dual-use space technologies and in particular the differing cultures of "Merchants" and "Guardians."<sup>1</sup> The Merchants represent the forces of technology and business innovation while the Guardians represent regulators and policy-makers concerned with security and stability. Many space policy debates over licensing, spectrum management, and export controls could be characterized by tensions between these two cultures as space commerce grew and spread.

The Merchants and Guardians dichotomy describes competing interests but does not specify a large objective toward which both cultures might strive. The early phase of the Second Space Age, starting roughly with the Space Shuttle program and ending after 9/11, was characterized by the growth of new commercial and international space actors in a strategically stable space environment. The current phase, starting roughly with the 2007 Chinese ASAT test and continuing today, sees continued growth in commercial and international space actors but in an increasingly volatile space environment. Interest in space governance to deal with space debris, space weapons, and even space property rights seems to coincide with the increasing perception that space is becoming less governable and stable than ever before. For some, this has spurred work on governance models to create greater clarity and certainty for new actors and activities in space.

Developing countries, as well as small and medium space powers, recognize the importance of the space domain to their national interests. However, their ability to directly influence what happens in space is much less than those of three major space powers that are permanent UN Security Council members, the United States, Russia, and China. Unfortunately, the regional interests of Russia and China are at odds with those of their neighbors and established international norms (e.g., the Ukraine invasion and claims in the South China Sea). The unwillingness of the United States to embrace an unverifiable and flawed space arms control treaty proposed by Russia and China illustrates the gap between the respective strategic interests of the major space powers.<sup>2</sup> On the other hand, Russia, virtually alone, is opposing consensus on UN guidelines for the long-term sustainability of space activities due to unrelated provisions in the draft international code of conduct for outer space dealing with the removal of potentially harmful space objects.

Russia and China are the immediate causes of instability in the space domain, due to their development of counterspace capabilities that threaten U.S. and allied space systems, and their decades long insistence on arms control proposals they know the United States and its allies cannot accept. However, the United States has contributed to weakening international space relations due to its own actions, notably in the civil space sector. At home, GPS, commercial remote sensing, and satellite communication companies have had to battle hostile and unresponsive regulators. The United States has failed to invest in crucial technologies, such as next generation liquid rocket propulsion engines and space nuclear power sources. The pipeline for new robotic science missions is increasingly thin and drying up, placing U.S. scientific leadership at risk.

Let me now “shift gears” and briefly discuss a different regime, the maritime regime, and then draw some analogies between security interests in space and on the high seas.

### The Maritime Regime

The joint statement from the 2011 Japan-U.S. Security Consultative Committee (2 + 2) meeting mentioned the use of space capabilities for Maritime Domain Awareness (MDA) as well as cooperation in satellite navigation systems and space situational awareness (SSA). This statement was followed up by a proposal to conduct a tabletop exercise (TTX) focusing on the use of space for MDA, presented by the United States at

the first U.S.-Japan Comprehensive Dialogue on Space in 2013. The proposal was well received and bilateral cooperation has grown each year since then. In the future, it is possible to imagine expanding cooperation to include countries such as Canada, Australia, and India.

A number of important issues need to be addressed as MDA cooperation grows. For example, the link between data derived from space systems and the allocation of budget resources is still vague, at present. Providers and users of MDA capabilities need to have a better understanding of the connections among data, analysis, and actionable information. What are the links among processes that characterize maritime activities (i.e., legal or illegal, threatening or benign), operational command decision-making (e.g., search for, interdict, pass to another component, etc.), and the expenditure of resources (e.g., fuel, manpower, ship time)?

### Comparing Space and Ocean Governance



Orbital ATK's Cygnus cargo craft is seen from the Cupola module windows aboard the International Space Station on October 23, 2016. The main robotic work station for controlling the Canadarm2 robotic arm is located inside the Cupola and was used to capture Cygnus upon its arrival. The Expedition 49 crew will unload approximately 5,000 pounds of science investigations, food and supplies from the newly arrived spacecraft. *Image Credit: NASA*

Humanity's experience with the oceans goes back thousands of years while our experience with outer space is not yet a century old. Different maritime zones beyond national jurisdiction, such as the high seas and the deep seabed, are subject to entirely different legal regimes. Under the United Nations Convention on the Law of the Sea (UNCLOS), the high seas include a range of “freedoms” and are open to use by all, whereas the deep seabed is said to be the “common heritage of mankind,” which is subject to an international regulatory system for mineral exploitation. Such differentiation does not exist for outer space.

Outer space is open for access to all states but it is not a “global commons” as there is no agreement or customary international law that recognizes it as one. Nonetheless, analogies exist among the issues faced by both domains. There can be tensions between the freedom of navigation and resource claims at sea; such conflicts contributed to the U.S. decision to not ratify UNCLOS, while still voluntarily abiding by its provisions. Similarly, there can be tensions between common interpretations of outer space law and the accommodation of new space activities, such as private use of in-space resources.

The ability to transit and use the resources of the oceans are important to all nations. In the future, the ability to use the resources of space as well as to transit the space domain will be important to the world. In support of these activities, accurate and timely information about activities within any international domain, whether the oceans, airspace or outer space, is necessary for stability and security. MDA and SSA capabilities are foundational for the governance of their

respective domains. Thus, for entirely pragmatic as well as idealistic reasons, it is appropriate and necessary that the United States and Japan cooperate closely in improving their MDA and SSA capabilities. This includes not only bilateral cooperation but cooperation with all countries in the region to the extent that this is possible and practical. In addition to international cooperation, internal, interagency, and interministerial coordination and crisis management skills are critical. In order to work more effectively with each other, the United States and Japan need to practice and demonstrate cooperative activities not only with each other but also across multiple responsible government organizations. This applies to both the oceans and outer space.

## **BUILDING AND SUSTAINING INTERNATIONAL ORDER**

The Cold War has been over for twenty-five years but the need for the Japan-U.S. Security Alliance is greater than ever. Today, the challenge is not to contain an aggressive Soviet Union but to ensure the maintenance of a peaceful and stable international system in the Asia-Pacific region. This system faces both opportunities and challenges in encouraging more nations to be responsible stakeholders in that system. China is not the only challenge, however. Non-state actors conducting insurgent, terrorist, or criminal activities in the maritime domain are also a challenge to international stability and security — and ultimately to the rule of law and

*“If like-minded states are to succeed in improving the stability of maritime and space domains, we should understand that this represents not just a balancing of national security and economic interests, but a shaping of the international environment in support of order and modernity against the very strong forces of disorder and chaos.”*

international order. For the past 70 years, the United States has sought to be an order-building power, not an expansionist or hegemonic one.<sup>3</sup>

The Cold War may be long past, but there is a need for allied leadership in international domains beyond areas of traditional sovereignty, such as the oceans, international air space, the poles, space, and even cyberspace. In a world beset by disorder, orderbuilding powers need to work together in the maritime and space domains. One of the most important order-building issues on the high seas is ensuring adherence to international law and custom for freedom of navigation. For the space domain, one of the most difficult issues is neither access to space or even the use of space resources, but defining armed conflict in space and the applicability of the laws of war. As seen in debates over the International Code of Conduct (ICoC), there is not an international consensus on the use of force in space or even the legal applicability of the inherent right of self-defense in space.

### **Self-Defense in Space**

In 2007, Estonia was subject to a wide-ranging series of cyber attacks against government ministries, the parliament, banks, newspapers, and broadcasters. Widely attributed to be of Russian origin due to their sophistication and persistence, the cyber attacks prompted new attention to international law in the cyber domain. In 2009, the NATO Cooperative Cyber Defence Centre of Excellence convened an international group

of legal scholars and practitioners to draft a manual on how to interpret international law in the context of cyber operations and cyber warfare. This effort resulted in the *Tallinn Manual on the International Law Applicable to Cyber Warfare* or simply the *Tallinn Manual*.<sup>4</sup>

As might be expected, no such manual or study exists for armed conflict in space. Debates on the use of force in space in international forums quickly reveal a divergence of views and a lack of expert discussions on the interlinked concepts of security, sustainability, and the potential for conflict in space. Some see outer space as a sanctuary, where the use and exploration of outer space is the province of all humankind, and where space activities can only be conducted for peaceful purposes. Others are concerned that the growing use of space for national security purposes could lead to attacks on space systems as part of future conflicts on Earth.

To explore these issues, the Secure World Foundation, in collaboration with my home institution, the Space Policy Institute (SPI), convened a workshop on September 9, 2015, in Washington, D.C., to discuss three hypothetical yet plausible scenarios exploring issues of self-defense and conflict in outer space. The workshop included experts from academia, international organizations, nongovernmental organizations, and the public sector in non-official capacities. Some had extensive experiences with space systems while for others space

operations were an unfamiliar subject. As part of the scenarios, participants considered questions such as:

- Does uplink jamming that prevents command and control of a satellite and degrades military capability constitute an armed attack?
- What is the legal standard for a pre-emptive attack on satellites in self-defense?
- What is the burden of proof for one country to demonstrate that another country is responsible for damage to its satellites?
- Can destroying a ground facility be a proportional response to attacks on a nation's satellites?
- Under what circumstances could the creation of a debris cloud in orbit be considered an armed attack on another country?<sup>5</sup>

Participants all felt that they had barely scratched the surface of what was needed to truly understand all the legal, political, and operational nuances of armed conflict in space. They pointed to the lack of clarity and consensus on the meaning of existing principles in international space law, and a lack of legal and political mechanisms for resolving situations without use of force. The national security space community overall lacks experience in dealing with *jus ad bellum* and *jus in bello* questions and an even greater lack of expertise and capacity with these issues within the international community. Some experts felt that the experience highlighted the importance of international discussions on norms of behavior and perhaps even new legal agreements, although most cautioned that much more

work would be required to increase understanding and build consensus before meaningful discussions were possible.

While recognizing the uncertainty and somewhat speculative nature of discussions of self-defense in space, the use of force, and armed conflict in space, several participants felt that the merely continuing status quo for space activities was dangerous. The increasing and somewhat unappreciated reliance on space systems by advanced and developing states could create unpredictable pressures for escalation and crisis instability should those space systems be threatened or lost.

## SPACE AND THE ROLE OF ORDER-BUILDING POWERS

In contrast to the hopes of the immediate post-Cold War era, an inclusive, rules-based international order has major opponents. The Soviet Union and the People's Republic of China were the most resistant to the order-building process begun after World War II, seeing such efforts as counters to the spread of revolutionary Communism. With the fading of Communism as a motivating ideology and the fall of the old Soviet empire, Russia and China have failed to offer attractive alternatives for international order. Instead, they seek to become regional hegemonies with familiar geopolitical spheres of influence. Both are capable of creating disorder and are able to deny the movement of people, goods, and even information, but are unable to create alternative institutions that attract willing allegiance. Further threats such as the Islamic State represent a return of pre-Westphalian power politics that rejects even the nation-state system accepted by Russia and China.

Robert Kagan of the Carnegie Endowment once observed about globalization that: "This explosion of commerce and trade rests on a secure international system, which rests on those who have the power and the desire to see that system preserved."<sup>6</sup> The oceans were the key to the growth of global trade in the 19th Century and they remain critical today. Space is critical to global information systems today, and resources as well as information from space may become important to global economic growth in the 21st Century. In both cases, the rules and norms for these domains will be created by states committed to being order-building powers. Space capabilities can provide important tools for creating the transparency and accountability needed to build societies and an international order based on the rule of law. Communication, navigation, remote sensing, and the fusion of data from multiple, overlapping sources

can help create predictability in an otherwise chaotic environment.

The United States and Japan are both maritime nations whose way of life depends on the free flow of maritime trade. Our mutual security and commerce depend today not only on the oceans but on international stability in many regions. I work in a school of international affairs where we have debates over areas beyond traditional definitions of sovereignty. The high seas and outer space remain frontiers, and are thus areas of potential conflict and cooperation among state and non-state entities. As with past frontiers, it is those who show up, not those who stay home, who create the rules and establish international norms that create stability and deter tragedies.

A distinction can be drawn between claims that can be resolved through existing agreements and processes and those, like the nine-dash line, which are not part of existing law. Resources and development claims are important to several states but challenges to the international system are important to all states. Such a challenge would be one that goes beyond economics, and seeks to impose a unilateral change to the status quo. Order is not a natural condition of the international system but one that must be sustained and built as leaving a vacuum is to invite danger. In a world increasingly threatened by the disorder of international terrorism, order building in the maritime and space domains is not only practical, but a hopeful symbol of what civilized, responsible states can achieve.

Being an order-building power is like flying an airplane – a light but active hand on the controls is required for stability. Mindful of history, we know that it is weakness, not strength that is provocative. If like-minded states are to succeed in improving the stability of maritime and space domains, we should understand that this represents not just a balancing of national security and economic interests, but a shaping of the international environment in support of order and modernity against the very strong forces of disorder and chaos. In space policy, the task ahead of us is to craft strategies and alliances that advance the values we believe in — free markets, democratic government, private property, and human rights — as human activities of all kinds expand into space.

2016 Elsevier Ltd. All rights reserved.

---

<sup>1</sup> Pace, Scott. Merchants and Guardians: Balancing U.S. Interests in Space Commerce. Santa Monica, CA: [RAND,1999]. Accessed at: <http://www.rand.org/pubs/reprints/RP787.html>.

<sup>2</sup> Rose, Frank. "Using Diplomacy to Advance the Long-term Sustainability and Security of the Outer Space Environment," U.S. Department of State remarks to the 31st Space Symposium, Colorado Springs, Colorado, April 16, 2015. Accessed at <http://translations.state.gov/st/english/texttrans/2015/04/20150417314715.html>.

<sup>3</sup> Nau, Henry R. Conservative Internationalism: Armed Diplomacy Under Jefferson, Polk, Truman, and Reagan. Princeton, New Jersey: Princeton University [Press,2013].

<sup>4</sup> NATO Cooperative Cyber Defence Centre of Excellence, Tallinn Manual, See <https://ccdcoe.org/tallinn-manual.html>.

<sup>5</sup> Secure World Foundation, "Scenario Workshop on Exploring Self-Defense in Space, Summary Report," Washington, D.C., October 29, 2015. Accessed at [http://swfound.org/media/205308/scenario-workshop-summary-report\\_29oct2015.pdf](http://swfound.org/media/205308/scenario-workshop-summary-report_29oct2015.pdf).

<sup>6</sup> Quoted in Friedman, Thomas. "Foreign Affairs; Techno-Nothings," opinion article in the New York Times, April 18, 1998. Accessed at <http://www.nytimes.com/1998/04/18/opinion/foreign-affairs-techno-nothings.html>.

# INTEGRATED COMMUNICATION EXTENSION CAPABILITY (ICE-CAP)

Peter J. Yoo, SPAWAR Systems Pacific

Nanosatellite technology made it possible for universities, commercial industries, and government agencies to develop low cost and responsive satellites. However, one of the limitations of this technology is the communications shortfalls due to short communication windows and long times between ground station contacts. Most nanosatellites are deployed to Low Earth Orbit (LEO), and because of that they are only within the line-of-sight of any given ground station antenna for a few minutes each day. The lack of available line-of-sight opportunities severely limits the capacity of Telemetry, Tracking, and Commanding (TT&C) and payload data transfer availability.

To address these limitations, the Navy's Space and Naval Warfare Systems Command (SPAWAR) System Center Pacific (SSC Pacific), with support from the Navy's Program Executive Office for Space Systems (PEOSS), has developed the Integrated Communication Extension Capability (ICE-Cap) satellite. ICE-Cap is a three-unit or 3U CubeSat, designed to work with the Mobile User Objective System (MUOS) UHF SATCOM system. The MUOS is the Navy's newest narrowband satellite communication system designed for use by the United States military and its allies. The MUOS is designed to replace the aging UHF Follow-On (UFO) satellite communications system, and once it is operational, it will be able to provide 10 times the data throughput of its predecessor. ICE-Cap is meant to serve as a force enhancer for satellite communication systems and is designed to provide communication and data relay capabilities for those warfighters outside of MUOS' area of responsibility.

An area of particular concern to the ICE-Cap mission is the North Pole. Outside of the MUOS area of operation, the North Pole has become increasingly significant as the sea ice in the region continues to melt and shipping and other maritime activity in the region increases. Because of the presence in the region of mineral and other resources, maritime shipping routes, and strategic military importance, the Arctic region is quickly becoming a contested area for the handful of countries possessing territory or operating in the region.

Due to US political, military, and economic interests, proper and adequate communications capabilities for our country and its allies are essential for sustained operations in the Arctic region. By leveraging the flexibility and adaptation capabilities of MUOS, and the relatively inexpensive funding requirements associated with nanosatellites such as CubeSats, a cheap and effective solution can be obtained with the combination of the two. ICE-Cap offers this solution by establishing a communications bridge, connecting the isolated user in the polar region with the MUOS SATCOM system.

## CONCEPT OF OPERATIONS

The ICE-Cap satellite is a technology demonstration CubeSat with two main objectives:

1. Demonstrate Legacy UHF SATCOM relay within the North Polar region
2. Mature and miniaturize radio, antenna, and other technologies for potential responsive UHF SATCOM missions.

The first objective is to demonstrate UHF SATCOM relay to the North Polar regions by two UHF terminals. User terminal "A" in the North Polar Region will uplink data to ICE-Cap when it is within line-of-sight. ICE-Cap will then relay the data through the MUOS Legacy payload. User Terminal "B" within MUOS line-of-sight will then receive the data from the MUOS Legacy payload. The test will measure data throughput between user "A" and user "B." The UHF SATCOM Relay concept is illustrated in Figure 1.

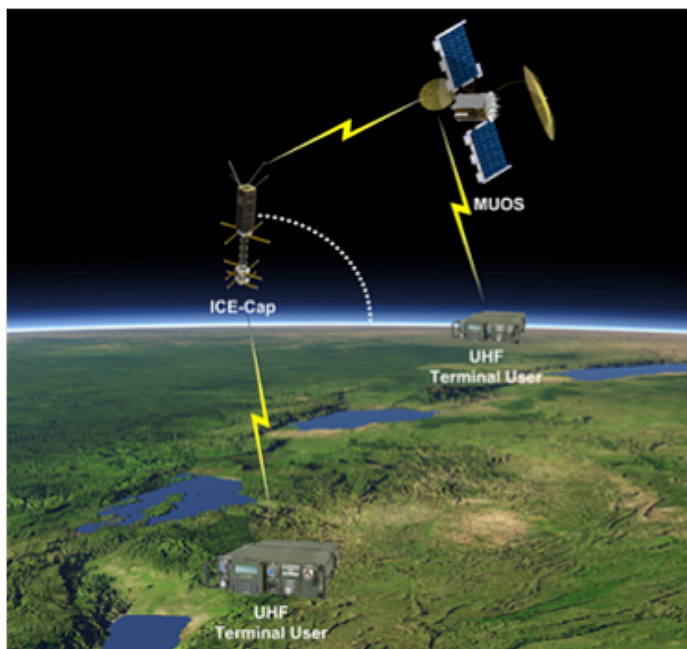

Figure 1: Legacy UHF Relay Operational View

The second objective is to miniaturize and mature the radio, the encryptor, and the antenna CubeSat hardware. The polarization and gain of the antennas that are integrated to ICE-Cap have been characterized and have been developed using all Commercial off-the-shelf (COTS) sub-systems. Current efforts are being focused on performing extensive environmental and compatibility testing on the ground.

## SYSTEM DESCRIPTION

The ICE-Cap project consists of four different Small Business Innovative Research (SBIR) projects. The table

below describes all organizations/companies participating in development and their functions.

Table 1: ICE-Cap Work Breakdown Structure

Function	Organization
Program Management	PEO Space Systems
System Engineering Support	SSC Pacific
SW Development / Integration	SSC Pacific
Ground Control Development	SSC Pacific
Ground Control Development Support	Naval Postgraduate School
HW Integration	Space Micro, Inc.
Low Gain Antenna Development	Space Micro, Inc.
High Gain Antenna Development	Physical Optics Corp
Radio Development	Vulcan Wireless
Cryptographic Unit Development	Innoflight

The ICE-Cap Space Vehicle (SV) is a 3U CubeSat. It measures 10 x 10 x 34 centimeters in the stowed configuration. The launch mass is currently estimated at 5.15 kilograms. Rendered depictions are shown in Figure 2.

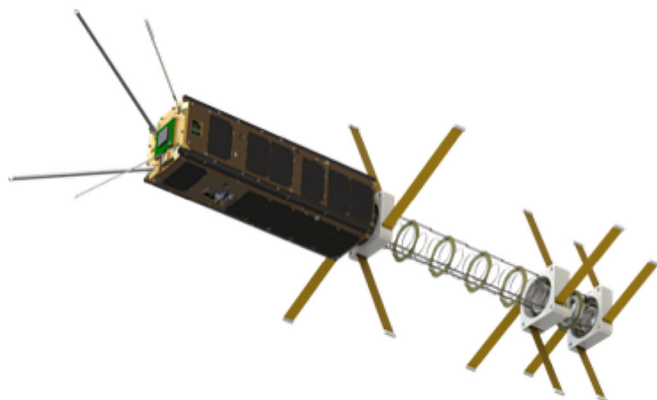

Figure 2: ICE-Cap CubeSat Image with Both Antennas Deployed

The space vehicle includes a software-defined radio (SDR), two deployable antennas – one high gain and one low gain antenna, an active attitude determination and control system (ADCS), a flight computer (FC), and an electrical power system (EPS). As in most other nanosatellites, ICE-Cap does not have a propulsion system and is therefore incapable of expending fuel to maintain an orbit. The space vehicle is designed to survive in orbit for approximately one year.

Each of the ICE-Cap subsystems has a level of autonomy sufficient to operate via basic state machine and is only intermittently controlled by the flight computer. The EPS takes power generated by the four solar panels and recharges batteries. The EPS also converts the battery power to other voltages necessary for operation. The flight computer accepts ground telecommand, maintains a real time clock, provides high-level coordination and fault

monitoring to other subsystems, maintains and initiates operational mission tasks based on a ground-defined schedule. The ICE-Cap SV attitude, (angle with respect to the surface of the earth) is controlled by the ADCS. The onboard SDR is used to command the space vehicle and report health and status data to the ground station.

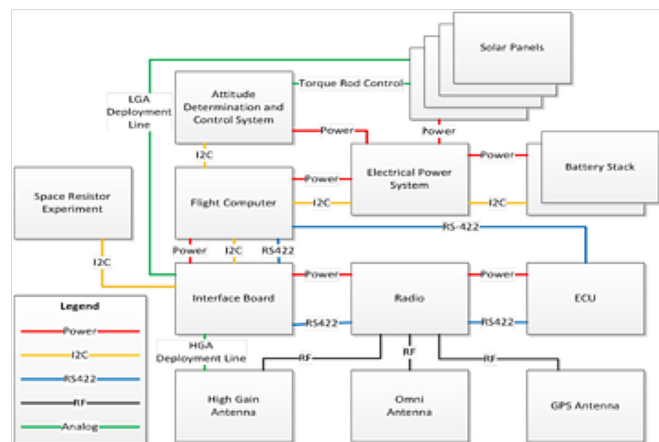

Figure 3: ICE-Cap Interface Architecture System Test Plan

## SYSTEM TEST PLAN

The ICE-Cap has three fundamental levels of testing: hardware environmental testing, software testing, and integrated system level day-in-the-life testing.

### Hardware Environmental Testing

The integrated ICE-Cap hardware has completed through a series of environmental testing to provide confidence in flight-readiness. The majority of the environmental testing is conducted at the Space Micro facility, the ICE-Cap SV system integrator. The hardware environmental testing includes:

- Vibration Testing – Vibration testing was performed with respect to General Environment Verification Standard (GEVS). Critical subsystems, and high risk components such as the deployable high gain antenna, were tested independently prior to integration.
- Thermal operations – multiple cycles of operations in thermal extremes at operational and safety limits were performed. Some of the testing was conducted at vacuum.
- RF antenna characterization was accomplished at the outdoor antenna range at SSC PAC.

### Software Testing

All flight software has undergone developmental, unit, and functional testing conducted by SSC Pacific, Space Systems Engineering group.

**Static Testing** – Code and peer reviews are done by the programmers informally. Code validation software is written by the developers to validate the functions implemented.

Integration Testing – Integration testing is a software verification and validation method in which an entire application or system is built and verified for expected operation. For the ICE-Cap Flight Software project, integration testing was conducted at least weekly. Each day, the entire software project was uploaded into a version control system.

**Functional testing** – Functional testing is a software verification and validation activity in which software functions and requirements are validated. Functional testing ensures that each requirement is met and that software operations and algorithms function as defined by the software requirements.

**System testing** – System tests focuses on the complete flow from creation through completion. These test cases serve to mimic user functionality. System test cases will be manually generated and executed. Once manual execution is successful and all defects have been resolved, the test cases can be automated. System test case automation is done by running a defined scenario for one or multiple days.

### Day-in-the-Life Testing

A “day-in-the-life” testing is a system-level test that tests all the elements of the spacecraft that will be necessary for its operation on orbit. ICE-Cap SV day-in-life testing involves exercising all satellite modes, including utilizing the SSC PAC ground station to send and receive messages to and from the satellite. This involves operating the satellite for multiple days with the ground station.

ICE-Cap is going through environmental and functional testing. The flight unit is shown in Figure 4 below.

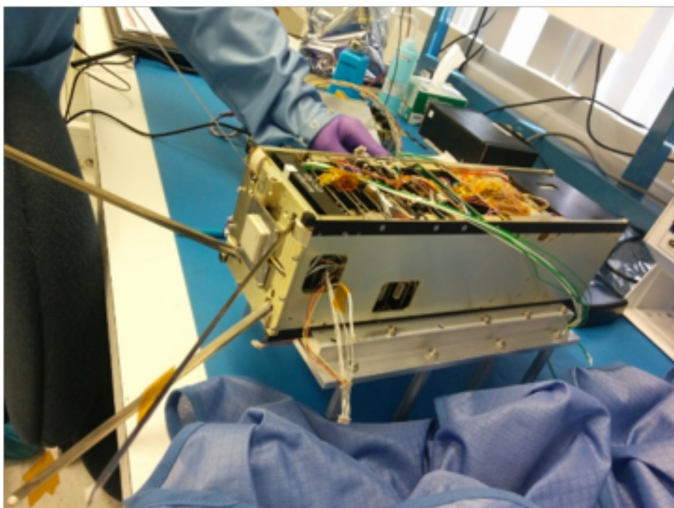

Figure 4: ICE-Cap fully integrated and ready for environmental testing

### LAUNCH AND ON-ORBIT OPERATION

At launch, the ICE-Cap Payload is stowed in the CubeSat Dispenser attached to the Evolved Expendable Launch Vehicle (EELV) Secondary Payload Adapter (ESPA) Ring.

While stowed in the CubeSat Dispenser, there is no power to the ICE-Cap Payload. After the ICE-Cap is deployed from the QuadPack dispenser, the ICE-Cap flight software operational timer is set for 30 minutes, after which the antenna deployment and the checkout begin.

Once safe launch and deployment occurs, ICE-Cap will begin the on-orbit checkout. The low gain antennas will be deployed individually by activating four burn wires with an interval of 30 seconds per antenna. Once the low gain antenna is deployed successfully, the FC will send a command to deploy the High Gain antenna. Once the flight computer verifies both antennas are successfully deployed, the legacy radio will begin to transmit periodic beacon messages and wait to receive a command from the ground. At the same time, the ADCS will begin to de-tumble the satellite and point the high gain antenna towards the earth.

After successful link establishment from the SV to GS, ICE-Cap will proceed with mode transition and start scheduling missions. Once the GS verifies all systems are functioning as expected, the GS will begin the on-orbit technical demonstration. In order to participate in the technical demonstration, participants need Military UHF SATCOM RF front-end equipment (tracking antenna preferred) and a computer with an appropriate SW suite that can be requested through SSC Pacific.

The ICE-Cap is scheduled to launch to a sun-synchronous orbit in early 2017. The ICE-Cap Ground Station in San Diego, CA will provide capabilities to command and control, retrieve, and analyze satellite data during the on-orbit phase. All development and testing is expected to be completed by September 2016 and delivery of the flight-ready unit to the launch provider will take place six weeks prior to launch.

Peter J. Yoo  
SPAWAR Systems Center Pacific  
Space Systems  
Austin Mroczek, PEO Space Systems, Assistant PEO for S&T  
Dmitriy Obukhov, Engineer  
Veronica Badescu, Engineer



# PROJECT INTEROPERABILITY IN PUGET SOUND (PIPS): A REGIONAL PERSPECTIVE ON ACHIEVING OPERATIONAL INTEROPERABILITY

Prepared by the Center for Collaborative Systems for Security, Safety and Regional Resilience (CoSSaR), University of Washington

## BACKGROUND

The attacks of September 11, 2001 (9/11) on New York City and the Pentagon have dominated our perspective on safety and security, shifting focus towards the critical role of information sharing and integration in “connecting the dots” between data collected from different sources and by different agencies. Numerous government agencies and industry consortia are working in various environments on projects aimed at achieving enhanced information interoperability. These projects all face numerous challenges, but the most fundamental of these challenges is that there is not yet a clear shared understanding of what it means to improve interoperability.

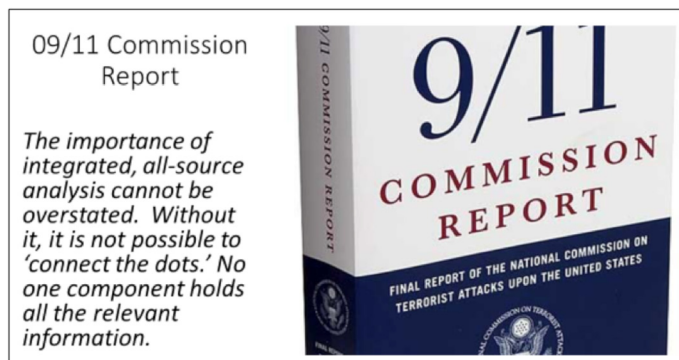

Source: The 9/11 Commission Report (2004)

Some projects rely on definitions of interoperability that focus on machines and data, viewing interoperability as a shared state of technical systems and devices that enables them to exchange understandable data. Other efforts, such as the European Interoperability Framework, put collaborative goals at the center of interoperability. This effort defines interoperability in the context of public service, and views interoperability as a collaborative state of organizations and people sharing information in service of a common mission. Tensions can arise between efforts based on improving interoperability as a more machine-and-data-centric, standards-based activity, versus those based on a view of interoperability as a more mission-centric, distributed understanding across people and organizations linked by a shared operational mission.

After 9/11, in an organizational effort to increase information sharing and coordinated effort, the

Homeland Security Act of 2002 combined 22 different federal agencies into a new cabinet-level agency, the Department of Homeland Security (DHS). Shortly after, in 2004, Congress established the Office of the Program Manager for the Information Sharing Environment (PM-ISE) was established within the Office of the Director of National Intelligence, with the mission to plan, oversee, and manage the Information Sharing Environment underscoring the importance of the ISE as a critical resource for homeland security and public safety. PM-ISE serves to direct responsible information sharing via evolving partnerships and collaborative growth of the ISE.

## PROJECT INTEROPERABILITY

In 2014, the PM-ISE launched Project Interoperability (PI), a partnership between the Federal Government and the Standards Coordinating Council (SCC). With an advisory body led by standards organizations, it is not surprising that machine-and-data-centric perspectives and issues were well represented. PI was described as a “start-up guide” providing “tools and resources... in different levels of maturity... with the content of Project Interoperability com[ing] directly from the I2F”—the ISE Information Interoperability Framework. I2F is described as “a framework from which concrete reference architectures and implementations are used to share or exchange information.” This focus on technology frameworks aligned with the stated goal of PI “to help government and non-government organizations identify a baseline of terms, tools, and techniques to connect networks and systems.” To further a technology framework for enhanced interoperability, PI presented ten “Interoperability Tools” which operate largely within the machine-and-data-centric perspectives of interoperability.

In spite of the architecture focus described above, however, the perspective of interoperability as a collaborative state of organizations exchanging information in service of a shared mission was also represented within PI. PM-ISE collaborated actively with operational agencies like the U.S. Coast Guard, and worked to highlight “the shared role by federal, state, local, tribal, and territorial ISE stakeholders.” Thus while I2F took its definitions of interoperability from more technical, machine-centric bodies such as

the IEEE, PI incorporated mission into its definitions, even when presenting a “technical perspective”: Information interoperability is the ability to transfer and use information in a consistent, efficient way across multiple organizations and IT systems to accomplish operational missions. From a technical perspective, interoperability is developed through the consistent application of design principles and design standards to address a specific mission problem.

The PI interoperability framework is comprehensive, using an extremely broad definition of interoperability that “includes both the technical exchange of information and the end-to-end operational effectiveness of that exchange of information as required for mission accomplishment.” This framework views interoperability as occurring at many levels, using the schema of an ‘interoperability continuum’, enabling a capability-based specification of design attributes for each level of interoperability. The levels of interoperability are: (0) No Interoperability, (1) Technical Interoperability, (2) Syntactic Interoperability, (3) Semantic Interoperability, (4) Pragmatic Interoperability, (5) Dynamic Interoperability, and (6) Conceptual Interoperability (see figure 1 below). Essentially, the lower-tiered levels of the continuum focus on technical and data related interoperability, and the upper-tiered levels lead us towards the operational, policy, and mission side of interoperability. Without detailing each of these levels, it’s evident that interoperability covers an array of issues from machine to data to mission, and that these issues

play out at many levels along an interoperability capability spectrum running from connected machines to measurably improved mission outcomes.

The mission of PM-ISE is broad: to promote and guide the development of ISEs to enhance national security and public safety through responsible information sharing. Not only is this mission broad, but as seen in the conceptual framework, it is many-leveled. To date, PI’s most concrete initial efforts to define interoperability tools have focused on addressing the lower levels of its “interoperability continuum.” The assumption of this approach is that PI can best guide the development of ISEs by first “advancing core frameworks and standards.”

### Project Interoperability in Puget Sound (PIPS)

PIPS was born out of a need to better understand the mission-centric, distributed stakeholder side of PI; to find out what impact, if any, the current PI tools are having on the regional operational communities; and to recommend how to best move forward to improve interoperability at the regional operational level. Thus, PIPS began by investigating three overarching questions:

- (a) How useful and applicable to mission accomplishment are the interoperability tools and concept?;
- (b) Why are some tools useful or not?; and,
- (c) What strategies can be used to improve tool design, usability, and outreach?

The overarching goal was to develop a plan for moving forward towards better-quality interoperability from the perspective of the diverse regional stakeholders.

In pursuing this goal, PIPS built upon a previous collaboration (the Maritime Operations Information Sharing Analysis--MOISA), which included PM-ISE, the U.S. Coast Guard Interagency Operations Centers Program (IOC), the National Maritime Intelligence-Integration Office (NMIO), and the University of Washington’s Center for Collaborative Systems for Security, Safety and Regional Resilience (CoSSaR). In the two years prior to PIPS, MOISA worked with partners across the Puget Sound security and safety community to analyze and understand the regional ISE. Rather than focus on emergency response and management, MOISA focused on the business-as-usual interagency information sharing processes, data, technology, and communication systems that support day-to-day maritime operations. MOISA found that daily operational information sharing among the diverse

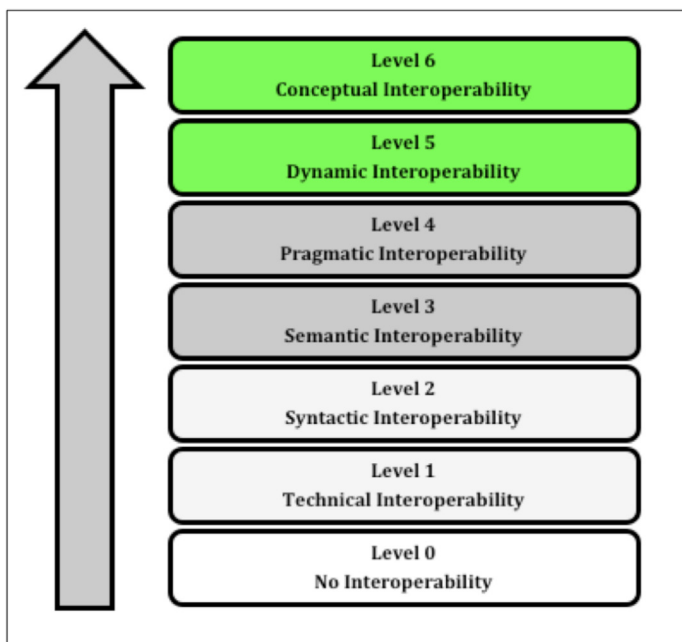

Figure 1. “Increasing Capability”, The Interoperability Continuum (from Interoperability, SCC whitepaper, version. 1, 12 October 2015).

set of agencies and stakeholders relied more on informal systems based on relationships and trust, using ubiquitous “technologies” like email, phone and meetings, than on formal systems of record with secure logons based on standards of identity management and access control. This is not to say that regional agencies are not using computational information systems and digital databases to accomplish their work, but rather that they are not using these largely disconnected systems to create and implement an information sharing community and environment.

Given this experience in MOISA, it is not surprising that PIPS found little direct impact through the use of formal PI tools on current regional interoperability mechanisms that support what is largely an “informal” information-sharing environment. Since MOISA focused on daily operations, PIPS also included an analysis of interoperability during disaster response and management operations. This allowed for the study of interoperability during both business-as-usual and emergency response situations involving incident command. The two cases selected for in-depth analysis were: (1) the planning and scheduling of an interagency operation to provide a security zone around a towed vessel, and (2) the requesting and tracking of assets following a major regional disaster.

Fortuitously, PIPS coincided with the largest regional disaster response exercise ever conducted in the Pacific Northwest – Cascadia Rising. This multi-state, international response to a massive Cascadia subduction zone scenario became the focal point for the second case, as well as an opportunity for further analysis of interoperability issues for a county Emergency Operations Center (EOC) engaged in emergency response. From these two cases and other analyses, researchers learned that during both business-as-usual and disaster scenarios, from the perspective of the regional operational community, interoperability is a mission-focused means rather than an infrastructure-focused end.

PIPS found that for regional agencies, an interoperable infrastructure that does not provide tangible operational enhancements to mission accomplishment is like a new highway or beautifully paved road that does not take them directly to where they need to go. There are always costs to the regional agencies to travel on this new highway, and to-date the benefits of travel have not outweighed those costs. Overall, augmented interoperability appears to hold the most value to the operational community when it offers a means to “buy-down” mission risk. Thus situations where lives are at risk and missions are endangered or

complicated by lack of communication, coordination and information sharing, offer opportunities to engage regional agencies in collaborative efforts to increase interoperability. That being said, however, PIPS saw that regional agencies will not act on this desire if doing so will seriously disrupt or take away from what is currently working. This hesitation was also echoed for incidents where it would place new restrictions on the current complex relationships and highly nuanced information sharing being relied upon to accomplish shared missions.

## CONCLUSION

The most critical challenge facing Project Interoperability is effectively partnering with regional operational communities to build increased interoperability into their current highly informal, trust-based information sharing systems. These trust-based systems are already working to form and connect operational communities as they work heroically to provide daily security and safety to the citizens and structures of their region. While there is ample room for interoperability improvement, this improvement cannot initially be achieved through mandated machine and data standards. PIPS found that technology issues were rarely the barriers to increased regional interoperability. Rather, there were numerous issues of motivation, legal concerns, community consensus, agency policies, cost, regional adoption, and mission coordination that had to be worked out before the current roster of PI tools could be applied.

In sum, PIPS research emphasizes that the “core interoperability framework” needs to be approached differently. Rather than begin with the bottom levels of interoperability as core components to be resolved and built on – a common machine-centric approach – it is the higher levels of conceptual alignment, captured in policy, community building and coordinated operations, that need to be resolved first and built upon. With these higher level issues addressed, the lower level machine and data standards become far more valuable as the instruments for achieving the higher level conceptual agreements.

For more information, please contact:

Prof. Mark P. Haselkorn  
Director, Center for Collaborative Systems for  
Security, Safety & Regional Resilience (CoSSaR)  
University of Washington  
markh@uw.edu  
206-543-2577  
UW HCDE Box 352315, Seattle, WA 98195

# TOWARDS REAL-TIME UNDER-ICE ACOUSTIC NAVIGATION AT MESOSCALE RANGES

Sarah E. Webster, Lee E. Freitag, Craig M. Lee, and Jason I. Gobat, Department of Ocean Physics, Applied Physics Laboratory, University of Washington

**Abstract**—This paper describes an acoustic navigation system that provides mesoscale coverage (hundreds of kilometers) under the ice and presents results from the first multi-month deployment in the Arctic. The hardware consists of ice-tethered acoustic navigation beacons transmitting at 900 Hz that broadcast their latitude and longitude plus several bytes of optional control data. The real-time under-ice navigation algorithm, based on a Kalman filter, uses time-of-flight measurements from these sources to simultaneously estimate vehicle position and depth-averaged local currents. The algorithm described herein was implemented on Seagliders, a type of autonomous underwater glider (AUG), but the underlying theory is applicable to other autonomous underwater vehicles (AUVs). As part of an extensive field campaign from March to September 2014, eleven acoustic sources and four Seagliders were deployed to monitor the seasonal melt of the marginal ice zone (MIZ) in the Beaufort and northern Chukchi Seas. Beacon-to-beacon performance was excellent due to a sound duct at 100 m depth where the transmitters were positioned; the travel-time error at 200 km has a standard deviation of 40 m when sound-speed is known, and ranges in excess of 400 km were obtained. Results with the Seagliders, which were not regularly within the duct, showed reliable acoustic ranges up to 100 km and more sparse but repeatable range measurements to over 400 km. Navigation results are reported for the real-time algorithm run in postprocessing mode, using data from a 295-hour segment with significant time spent under ice.

## I. INTRODUCTION

Autonomous platforms have been used under the ice as early as the 1970's when Francois and Nodland deployed the Unmanned Arctic Research Submersible (UARS) in the Beaufort Sea [1]. Since then, numerous autonomous underwater vehicles (AUVs) and autonomous underwater gliders (AUGs) have successfully performed under-ice observations. These under-ice missions have pushed the limits of existing technology and provided highly valuable scientific information, but the ability for an autonomous platform to consistently estimate its own georeferenced position in realtime with acceptable accuracy remains a challenge [2], [3].

Currently, most AUGs and AUVs rely on fixed acoustic sources for vehicle-based navigation, or, in the case of mobile sources, the position estimation is performed onboard the ship or on a basestation. Seaglider AUGs were first deployed under the ice in Davis Strait in 2006 and have continued to be deployed routinely since then, relying on moored RAFOS acoustic navigation sources [4], [5]. The Slocum AUGs also have ice-capable behaviors and routinely operate at the ice edge in Antarctica [6]. For AUVs, the most commonly used under-ice navigation strategy is a combination of long baseline (LBL) navigation

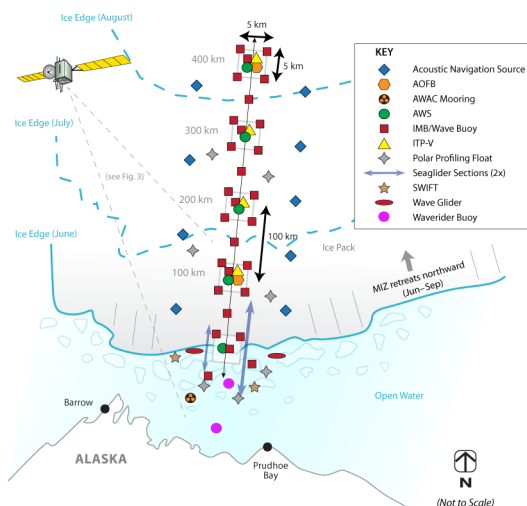

Fig. 1: Schematic of the marginal ice zone program field campaign [14]. Photo credit: APL-UW.

for its range and ultra-short baseline (USBL) navigation for its precision during homing maneuvers. Examples of this can be seen in the Odyssey [7] and Remus [8] AUVs. Additional approaches to supplement these methods include novel applications of LBL [9] and vision-based navigation for very short-range homing [10]. Single-beacon navigation is used by the Hugin [11] and Theseus [12] AUVs to extend their LBL systems by incorporating ranges from a single beacon when necessary. And [13] reports use of an upward-looking Doppler velocity log (DVL) on the Gavia AUV for ice-relative navigation.

In this paper we report on a real-time acoustic navigation system developed for the Office of Naval Research (ONR) marginal ice zone (MIZ) program [14]. The ONR MIZ program was designed to be an ice-based experiment, as shown in Fig. 1, as opposed to an ice breaker-based campaign or a subsurface mooring deployment. Because of this, the navigation sources could not be pre-deployed through the ice to rest on the seafloor. Otherwise, as the instrumented area of ice moved, the sources would not be in the correct position to support the AUGs making synoptic measurements with the sensors on the ice. In addition, because real-time position information was important for navigation of the AUGs, the time-of-flight measurements could not simply be saved and post-processed along with the known source locations (sent back via Iridium) after recovery. Instead the acoustic navigation sources were required to transmit their location so that the AUG could decoded and use it, thus motivating the design of a new generation of long-range, low-frequency navigation source: one that includes communications.

The concept of transmitting source location information along with timing data is not new; the global positioning

system (GPS) signals include low-rate telemetry data, and the concept has been exploited for small underwater networks with mobile navigation sources, for example in [15], [16], [17], [18] and [19]. However, this is the first time that such an approach has been used in the Arctic to make a complete navigation system.

The remainder of this paper is organized as follows. The acoustic navigation beacons and receivers are described in Sec. II. The real-time navigation algorithm is described in detail in Sec. III. The MIZ field campaign is briefly described in Sec. IV, followed by results and discussion in Sec. V. We conclude in Sec. VI with lessons learned and future work.

## II. ACOUSTIC NAVIGATION BEACONS AND RECEIVERS

The acoustic beacons and receivers are based on the Micro-Modem 2, a newer version of the Micro-Modem which has been in development at the Woods Hole Oceanographic Institution for more than 15 years [20], [21] and used in many underwater navigation systems [22]. The beacons (Fig. 2) are fabricated so that they will float when the ice melts, and include GPS receiver, Iridium satellite communications, low-frequency amplifier, and 900 Hz flexural disk transducer. The receivers are simply a Micro-Modem 2 circuit board and an omni-directional hydrophone from High-Tech Inc. While the beacons use a GPS for timing, the timing reference on the Seagliders are SeaScan Inc. temperature-compensated oscillators. The receivers are lowpower ( $< 0.5$  W), and are turned off when no incoming navigation receptions are expected. Likewise, the buoy beacons are off except when a transmission is scheduled. The beacons were designed for a minimum of 6 months of use when transmitting every four hours, but if equipped with a larger battery pack could last much longer (unless crushed or covered by ice).

The carrier frequency is 900 Hz, signal bandwidth is 25 Hz (both FM sweep for navigation time and for data), and the data is encoded with a low-rate error-correction that results in a data rate of approximately 1 bps. The source level is 183 dB re micro-pascal, which requires less than 50 W of power from the battery.



(a) Acoustic navigation buoy



(b) Flexural disk transducer

Fig. 2: Acoustic navigation buoy hardware. Initially deployed on the ice, the GPS- and Iridium-equipped buoy sits on the ice, while the acoustic transducer hangs below through a hole in the ice. The buoy is designed to survive the ice breakup. For the MIZ program, the transducers were at  $\sim 105$  m depth.

The beacon transmission consists of a frequency-modulated sweep, followed by a short gap, then phase-modulated data. The frequency-modulated sweep is detected at the receiver and used for the time-of-arrival estimate, while the phase-modulated signal is processed using an adaptive equalizer with embedded error-correction decoding and Doppler compensation. The accuracy of the time-of arrival estimate is a function of its bandwidth, the signal-to-noise ratio (SNR), and the channel response. Despite the modest bandwidth of  $B=25$  Hz, if only one ray is present and the SNR is high, the accuracy can be on the order of a few meters or better. To take advantage of this, the peak of the matched-filter output (sampled at  $2B$ ) is interpolated to find the peak, and this travel time is reported to the navigation system.

The data payload contains one byte of destination address and up to 9 bytes of configurable payload. We have divided this into source position, command, and target position as shown in Table I, where the command and target positions are used to send the glider to a specific location. The decimated source latitude and longitude are created by scaling latitude by 5000 and longitude by 2500 and rounding to nearest integer, which results in 22 m resolution in latitude and 10 m resolution in longitude at  $75^\circ\text{N}$ . Similarly, decimating the target latitude and longitude into 12 bits each results in a resolution of 5 km in latitude and 2.5 km in longitude at  $75^\circ\text{N}$ , adequate for the purposes of this program.

Table II shows the schedule of acoustic broadcasts for one cycle of transmissions; the cycle was repeated at the top of every fourth hour. To avoid interference between the signals from different sources, each source transmits at the beginning of its own four-minute slot. The signal takes up approximately one minute, which allows for approximately 240 km of channel-clearing time. The use of staggered transmissions results in range estimates made along a moving track and is one motivation for using a Kalman filter to properly integrate them into the navigation solution.

The receiver provides the time of arrival and packet data, including source position, to the AUG after the data are decoded. The AUG uses the source schedule to determine what minute the source transmitted and computes the one-way travel time. The transmissions are scheduled every four hours in this deployment, but that interval is programmable and can be changed if necessary depending on mission requirements.

## III. REAL-TIME ACOUSTIC NAVIGATION ALGORITHM

The acoustic navigation algorithm reported herein is a real-time implementation of the algorithm reported in [4], which is in turn based on the one-way-travel-time (OWTT) navigation algorithm reported in [15]. The real-time implementation, written in C, required a few modifications of the full 6 degree-of-freedom (DOF) model used in [4].

### A. State Vector and Process Model

For the real-time filter, as in [4], we use a constant-velocity process model. However, because of the limited processing power currently available on Seaglider, we reduced the filter state to track only position and associated velocities in the world frame (North, East, down), as shown in (1). Position North and East are recorded in minutes of latitude and minutes of longitude, respectively, while depth is in meters

and all velocities are in meters per second. Horizontal position is not stored in meters because the distances traversed by the AUG, and the distances between the AUG and the acoustic sources (hundreds of kilometers), make the use of a local origin impractical. However, because the navigation algorithm is implemented using single precision floating point numbers, numerical stability issues arose when converting between meters and degrees latitude or longitude in the state transition matrix. The use of minutes latitude and minutes longitude avoids this accuracy problem without resorting to the use of a local origin.

TABLE I: Breakdown of 72-bit acoustic packet payload.

# of Bits	Use	Resolution
20	source lat	22 m
20	source lon	10 m (at 75°N)
8	command	n/a
12	target lat	5 km
12	target lon	2.5 km (at 75°N)
<b>72</b>	<b>Total</b>	

TABLE II: Acoustic source broadcast schedule (repeated every 4 hours).

Source ID	Broadcast	Time Source ID	Broadcast Time
1	0:00	8	0:24
2	0:04	9	0:30
4	0:08	10	0:34
5	0:12	13*	0:38
6	0:16	14*	0:42
7	0:20		

\*Mobile acoustic sources mounted on Wave Gliders at 4.5 m depth.

$$\mathbf{x} = \begin{bmatrix} x \\ y \\ z \\ \dot{x} \\ \dot{y} \\ \dot{z} \end{bmatrix} \begin{array}{l} \text{[minutes latitude]} \\ \text{[minutes longitude]} \\ \text{[meters depth]} \\ \text{[meters/second N]} \\ \text{[meters/second E]} \\ \text{[meters/second down]} \end{array} \quad (1)$$

When AUG attitude is required, e.g., for transforming body velocity estimates into the world frame, the most recent compass reading is used without filtering. This approach for a reduced-order model is a common simplification for real-time operations when attitude and depth are well-instrumented and have bounded error.

The reduced-order state vector and constant-velocity process model result in a nearly linear state transition matrix (2), shown here in discrete time, where  $m_{lat}$  and  $m_{lon}$  are meters per minute of latitude and longitude respectively.

Note that  $m_{lat}$  is constant, but  $m_{lon}$  varies with the cosine of latitude. This cosine prevents the process model from being strictly linear. However, in practice the latitude changes so slowly with each timestep that we are able to treat this term

$$\mathbf{x}_{\kappa+1} = \begin{bmatrix} I & F \\ 0 & I \end{bmatrix} \mathbf{x}_{\kappa} \quad (2)$$

$$F = \begin{bmatrix} \Delta t/m_{lat} & 0 & 0 \\ 0 & \Delta t/m_{lon} & 0 \\ 0 & 0 & \Delta t \end{bmatrix}$$

as constant for each prediction step. As a result, we avoid a computationally costly linearization at each prediction step, compared to the 6 DOF model. Even more importantly from a computational standpoint, this enables us to perform a single prediction between measurements regardless of the size of the time step. This is in contrast to the nonlinear process model reported in [15], which requires a limit on the maximum length of a single prediction step to prevent large linearization errors, thus requiring multiple prediction steps to advance the filter state up to the time of the next measurement.

The use of a single prediction step between measurements is especially important for Seaglider operations because of the paucity of sensor measurements compared to traditional AUVs. As shown in Table III, up to 30 seconds elapses between sensor measurements while the AUG is diving, and often a *minimum* of 5 minutes elapses between the two GPS fixes on the surface, during which time no other sensor measurements are available.

TABLE III: Typical Seaglider sampling schedule.

Vehicle Depth	Frequency	Sensor Measurement
surface	twice per dive	GPS
5–250 m	every 10 sec	pressure, roll, pitch, heading, and estimated velocity (from pitch and buoyancy)
250–1000 m	every 30 sec	
any depth	every 4 hours	acoustic broadcast from each source

## B. On-Board Sensor Measurements

Seaglider AUGs carry a minimal sensor suite for navigation. The Seagliders deployed during the experiments described herein carried only a Sparton compass (SP3004D), a Paine pressure sensor (Model 211-75-710-05, a strain gauge sensor with 1500 psi full-scale range and 0.25% FS accuracy), a Garmin GPS sensor (GPS-15xH), and the navigation receiver described above. The uncertainties assigned to each observation model are shown in Table IV.

TABLE IV: Seaglider navigation sensor model uncertainties.

Measurement (Sensor)	State	Uncertainty
pressure (Paine)	$z$	0.5 m
velocity (buoyancy & pitch) <sup>y</sup>	$\dot{x}, \dot{y}$	0.06 cm/s
acoustic range	$x, y$	4.0*(range in km) m <sup>z</sup>

<sup>y</sup> The Seaglider hydrodynamic model uses pitch and either buoyancy or vertical velocity to predict angle of attack and forward velocity.

<sup>z</sup> We also set a minimum uncertainty of 50 m.

To provide a sense of velocity through the water, we use the Seaglider hydrodynamic model. Described in detail in [23], the lift and drag model parameters are tuned for each Seaglider after deployment in order to provide an estimate of forward velocity and the angle of attack based on pitch and either vertical velocity or buoyancy. The resulting velocity estimate is incorporated into the filter as a measurement.

While it may seem indirect to treat the hydrodynamic model output as a measurement, as opposed to using the hydrodynamic model as the process model for the filter, there are two reasons that we do this. First, the hydrodynamic model is not used as the AUG process model because it is highly nonlinear and would require linearization with each prediction step, imposing the limitations described in Sec III-A. Second, the hydrodynamic model is used within the Seaglider software to estimate velocity whenever a compass reading is taken regardless of what navigation algorithm is running. Therefore it saves processing time to use the output of that function call as velocity pseudo-measurements instead of calling the hydrodynamic model function again for each prediction step.

### C. Acoustic Range Estimates

The range between an acoustic navigation source and the AUG is estimated using the time-of-flight of the acoustic message broadcast. As described in [24], we can treat these range measurements as independent and uncorrelated because the acoustic source positions are based on GPS measurements. The uncertainty assigned to the acoustic range observation model was determined experimentally using the range innovations to tune the Kalman filter. A range dependent error model is employed because of the expected effect of ray bending, compounded by long distances, when the receiver (the AUG) is at a significantly different depth from the source. As reported in Table IV, we found an uncertainty of 4.0 m per km of range produced consistent filter results.

Calculating the AUG's range from the sources based on the one-way travel time requires synchronized clocks on the sources and the AUGs and assumptions about sound speed and ray bending. Navigation source clocks receive a pulse-per-second (PPS) signal directly from GPS. Seascan Inc. clocks are used onboard Seagliders for a stable reference and these are disciplined with every GPS fix. With a drift rate of 0.001 second/day, 10 days under ice without a GPS fix would result in only 15 m of error in range. The local sound speed at the AUG at the time of reception is used to estimate range from time-of-flight. While not optimal, we have not yet developed a method for estimating the sound-speed along the path from source and receiver by taking advantage of *in situ* measurements and climatology.

### D. Under-Ice Current Estimates from the AUG

Most AUGs provide an estimate of depth-averaged current (DAC) based on the difference between their estimated dead-reckoned surfacing position and their actual surfacing position (from a GPS measurement). AUGs are able to use this estimated DAC to account for current-induced set and drift and adjust the desired heading for the next dive accordingly, resulting in straighter tracklines and more headway toward the desired target. One of the unique contributions of the navigation algorithm presented herein

is the addition of an average current calculation based only on range measurements, that can be made while the AUG is under ice without access to GPS.

Within the Kalman filter framework, the standard DAC can be found by dividing the GPS measurement innovation by the time since the previous GPS measurement. As part of the real-time algorithm, we implemented a method to estimate range-based averaged currents (RACs), which represent the average current experienced by the vehicle between cycles of range measurements. Because the acoustic broadcasts are tightly grouped, a local minimum of uncertainty in vehicle position is achieved at the end of each cycle of transmissions. To estimate the effect of current on the vehicle's trajectory between local minimums, the algorithm keeps a cumulative sum of the x- and y-components of the range innovations during each cycle of transmissions. At the end of each cycle, the cumulative innovation is divided by the elapsed time since the last RAC calculation (at the end of the previous cycle of transmissions) to estimate the new RAC.

Unlike DAC estimates, RAC estimates do not represent a full depth-averaged current because the vehicle traverses variable portions of the depth profile between each cycle of range measurements. The extent of the depth profile that is traversed is not knowable *a priori* because it depends on the real-time operation of the vehicle compared to the timing of the broadcasts. As a result, the RACs may not be a suitable substitute for DACs for navigation purposes in strongly vertically stratified currents without taking the vehicle depth trajectory into account.

The fidelity of the RAC estimates are highly dependent on the quantity and accuracy of the range measurements, because these determine the uncertainty of the vehicle's starting and ending positions. If the cumulative uncertainty divided by the time is too large, the RAC estimate cannot be differentiated from noise. Given suitably accurate range measurements, however, with good throughput (where 'good' depends on the sensor suite and the deployment), we believe that this method could provide similar capability to the DAC estimate for real-time set and drift correction without requiring access to the surface.

## IV. MARGINAL ICE ZONE FIELD CAMPAIGN

The marginal ice zone field campaign ([14]) began in March when a small subset of the research team mobilized in Sachs Harbor, AK. All of the ice-based assets were deployed by plane, setting up camps on the ice as necessary. The science instruments were placed near 137°W, grouped into four clusters spaced approximately 1.0° latitude apart, from 72.5°N to 75.5°N. The acoustic navigation sources were placed in two rows on either side of the line of instrument clusters, to provide optimal acoustic coverage while the Seagliders transit near the clusters (see Fig. 1).

At the end of July, another team mobilized in Prudhoe Bay, AK, to deploy the mobile assets by small boat—four Seagliders, two Wave Gliders carrying acoustic navigation sources, two SWIFT buoys, and a WaveRider mooring. Once deployed the Seagliders and Wave Gliders moved north towards the array—the Wave Gliders providing acoustic navigation while staying clear of the ice, the Seagliders transiting under the ice and ice-fast instruments.

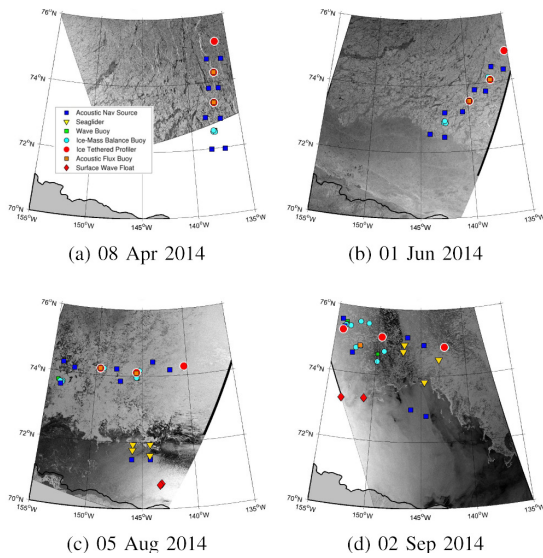

Fig. 3: Progression of the instrument array deployed north of Alaska, with satellite imagery underlaid when available. This shows the extreme deformation of the array of instruments, including the acoustic navigation beacons (blue squares) and the Seaglider deployments (yellow triangles). (a) Initial deployment of ice-based instrumentation. (b) Deformation of array after seven weeks. (c) Four Seagliders, two Wave Gliders with acoustic beacons (blue squares), and two SWIFT buoys (red diamonds) are deployed in open water south of the array. (d) Seagliders sample under the ice 15 days before the 2014 sea ice minimum.

Figure 3 shows the evolution of the ice pack during the seasonal melt from April through September 2014, and the movement of the ice-fast and mobile assets deployed as part of the MIZ field program. The Seaglider campaign finished in early October when they were recovered after swimming south out of the reforming ice.

## V. RESULTS AND DISCUSSION

In

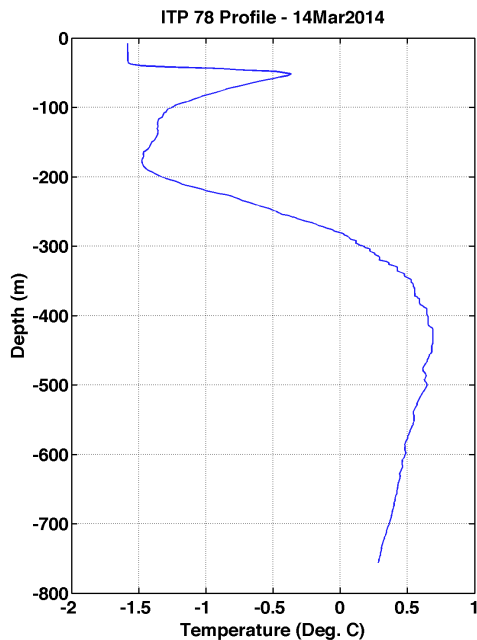

Fig. 4: Temperature versus depth in the central Beaufort in March when the buoys and other fixed sensors were deployed. This profile results in a sound channel between approximately 50 and 250 m.

this section we summarize the performance of the travel time estimates made from transmissions between pairs of beacons, and from the beacons to the Seagliders. We also show results from the real-time navigation algorithm and current estimation using acoustic ranges.

### A. Beacon-to-Beacon Performance

The receivers on each of the buoys are enabled during the entire period when they transmit, and thus we were able to monitor the performance of the system as soon as the network was deployed in late March. While the original plan for positioning was based on maximum ranges of approximately 100 km, it soon became clear that the system was operating at three times that estimate. Ice-tethered profilers [25] that were deployed at the same time showed the reason: a strong duct was present between 50 and 250 meters due to warm Pacific water above (at 50 m), and warm Atlantic water below (Fig. 4). The upper layer of the duct prevents the signal from interacting with the ice, where it would scatter, and the lower layer also refracts the signal back into the duct without loss. The presence of this duct was anticipated based on the analysis of historic data, which informed the beacon transducer placement at 105 m depth, but the strength of the sound channel was not.

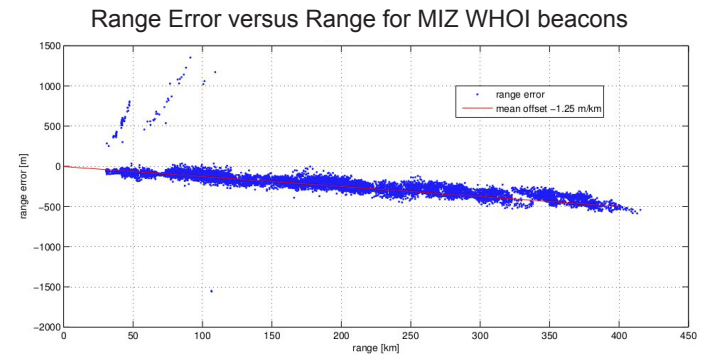

Fig. 5: Error in acoustic range estimates versus range between the ice-tethered acoustic navigation sources located in the sound channel, assuming a sound speed of 1437.2. The red line represents a range dependent offset of -1.25 meters per kilometer of range, which can be removed by adjusting the sound speed. Note that the precision is not range-dependent.

Additional key features of the duct are that it is stable and has similar shape throughout the Canada Basin; and that it is narrow, which results in minimal time spread of the wavefront. As a result the range estimate errors, made by comparing the measured travel times versus the ranges computed from the GPS positions, are independent of range, as shown in Fig. 5. The standard deviation of range error computed for one source-receiver pair (buoy 6 to 4) at approximately 200-250 km range was 40 m (Fig. 6). The success rate (percentage of the receptions that were detected acoustically and that were decoded successfully) was typically greater than 95%.

### B. Beacon-to-Seaglider Performance

While the beacon-to-beacon transmissions were made in the duct, the Seagliders, by nature of their buoyancy-driven propulsion, were only in the duct a fraction of the time and not necessarily during a transmission window. Thus the performance of the receivers mounted on the Seagliders did not achieve the excellent range performance of the



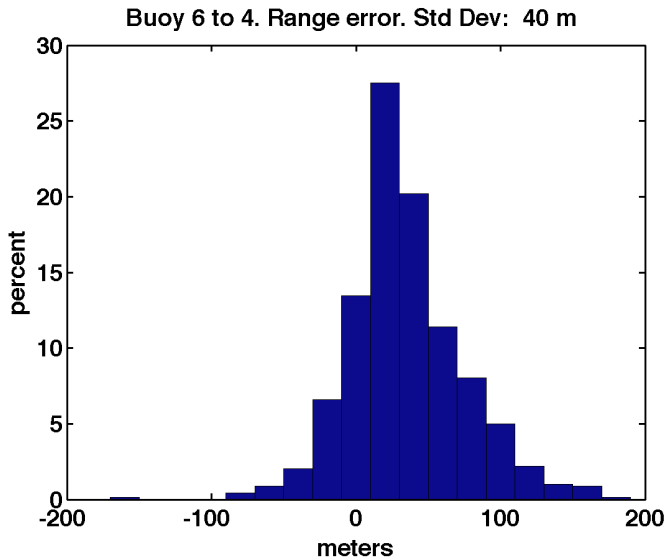

Fig. 6: Histogram of the error in the acoustic range estimates between sources 4 and 6 after adjusting the sound speed.

beacon receivers. However, the following observations may be made.

- For ranges less than approximately 100 km, the original design criterion of the navigation system, the Seagliders routinely heard the beacons and approximately half the time successfully decoded the source position data transmitted with it.
- At ranges from 100 to 300 km when receptions were made between the surface and 200 m depth, the majority of the detections resulted in good source locations.
- From 300 to 450 km the receptions with travel times that were deemed correct based on their arrival time very rarely had good associated source locations.

The reasons for the difference in performance are most likely due to propagation conditions in and out of the duct. Receivers in the duct hear the source at any range, while those outside the duct are in a range-dependent environment where signals come and go depending on the ray paths.

### C. Navigation Algorithm Performance

The navigation algorithm ran on the Seagliders, in realtime, for the first ~70 dives of each of the four deployed vehicles. Due to outside circumstances, real-time results from this algorithm are not available for the remainder of the deployment. The results presented herein are from post processed analysis, however they use only the data that was available in real-time—raw navigation data and only the acoustic transmissions that were successfully decoded by the AUG in real time.

Figure 7 shows the filtered vehicle trajectory of sg198 for dives 193 to 272, a 295-hour segment during which the AUG successfully decoded 58 acoustic navigation packets. For comparison the dead-reckoned trajectory is

shown in blue, for which GPS fixes were allowed but no range estimates were used. GPS fixes are shown in black.

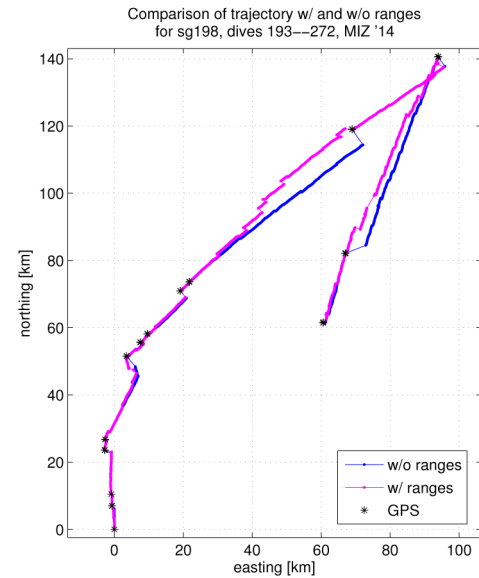

Fig. 7: Comparison of the dead-reckoned versus range-aided trajectory of sg198 during a 295-hour segment with some portions under the ice.

Figure 8 shows the range measurement innovations for the same segment, color coded by acoustic source, with the 3-sigma measurement covariance limits shown in dashed magenta. The innovations for most of the sources lie within the 3-sigma bounds, indicating consistent measurements. Source 6, however, is clearly outside of the covariance bounds, with innovations around 15 km. The exact nature of the error is still under investigation, but possible causes are ray bending compounded by long ranges (~450 km) and variability in the surface ice or clock drift/offset.

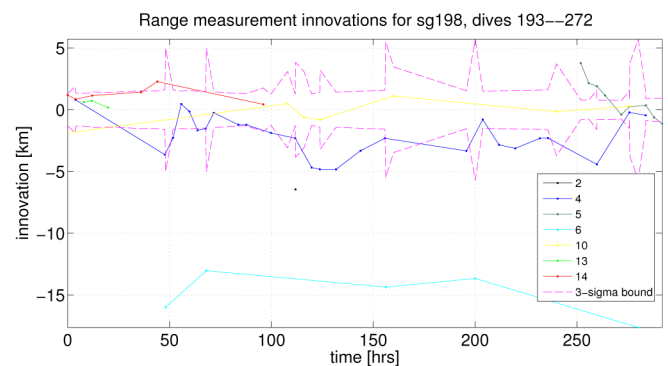

Fig. 8: Range innovations with the 3-sigma covariance bound or the 58 acoustic navigation packets decoded in real-time during the 295-hour segment shown in Fig 7. Innovations are color coded by source.

### D. Under-Ice Current Estimates

As described in Sec. III-D, it is difficult to quantitatively compare RAC and DAC estimates without an external ground truth, and the fidelity of the RAC estimates are directly affected by the position uncertainty in the vehicle trajectory.

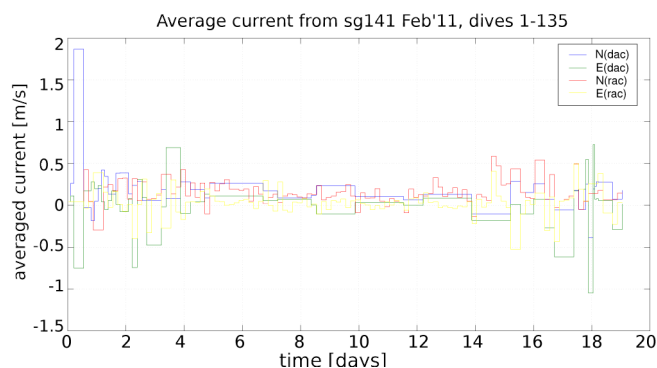

Fig. 9: Stairstep plots of North and East components of the average current calculated on a per-dive basis when GPS is available (DAC) versus after each cycle of range estimates (RAC). The lack of GPS measurements results in the DAC not being updated as often as the RAC; the large DAC after the first dive is a processing artifact.

By design, the sources for the MIZ experiment were placed hundreds of kilometers apart to provide coverage over a large area. In the initial deployment the sources spanned 379 km, which spread to 461 km by the time the Seagliders were deployed, and continued to spread from there. As a result, range measurements from the MIZ experiment are too sparse to reliably compute RAC estimates, because the Seagliders rarely received more than one or two range measurements per cycle.

Instead, we will illustrate RAC estimation using data from a previous Seaglider deployment in Davis Strait. In Davis Strait, seven acoustic sources were deployed across 140 km, with a transmission cycle of 6 hours [4]. During each cycle, the Seaglider often receives a minimum of three range estimates. Figure 9 shows a comparison of range-average current estimates and depth-averaged current estimates from a section in 2011 where the vehicle was under ice with only periodic surfacings. Estimates are plotted as a stair step, such that the current shown at any given time is the current that was calculated at end of the previous cycle.

The caveat in this analysis is that the range estimates in Davis Strait have significant uncertainty, 1.5–3 km, such that a typical 3-sigma position uncertainty after a transmission cycle could be up to 500 m. With that magnitude uncertainty on either end of a 6 hours dive, any current estimates less than 5 cm/s are undifferentiable from noise. Thus, without better data or ground truth for comparison, we do not yet make any quantitative claims about the RAC estimates. This comparison does show, however, that the RAC estimates are both larger than what we estimate to be noise, and are within reasonable bounds for typical currents in Davis Strait.

## VI. LESSONS LEARNED AND FUTURE WORK

We described herein the design of a real-time, under-ice, mesoscale acoustic navigation system, including new hardware and a navigation algorithm that, in addition to vehicle position, is capable of estimating average subsea currents from acoustic range estimates when GPS fixes are unavailable. We presented initial experimental results from a deployment of the navigation system and four Seaglider AUGs in the marginal ice zone of the Beaufort Sea during the 2014 seasonal summer ice melt.

The acoustic navigation beacons provided reliable acoustic range estimates and data transfer to the AUGs throughout the water column out to 100 km with approximately 50% throughput. Range estimates and data transfer within the sounds channel (50–200 m) were reliable out to 300 km with occasional receptions out to 450 km.

Post-processed results from the navigation algorithm show that it is effective in both estimating vehicle position and produces average current estimates that are consistent in magnitude with depth-averaged currents, given adequate range data.

Several operational lessons were learned from this field program. First, the strong acoustic channel significantly degraded the throughput of acoustic navigation packets when the AUGs were outside of the sound channel. Coordinating acoustic transmissions and the AUG residence in the sound channel should improve throughput. Second, in post processing we were able to infer the source of many of the transmissions when the data packet was not successfully decoded. For the dives analyzed here, this would have added 25 range hits to the original 58. Adding this logic and a simple filter to predict source locations could provide useful range data at longer distances, especially in the absence of proper range hits. Finally, a clock problem on one of the AUGs rendered real-time acoustic navigation unusable. Diagnosing clock problems automatically would not be difficult, so implementing a back-up strategy would be advantageous, especially for long missions under the ice.

Additional future work includes additional analysis of the navigation and science data from the MIZ experiment. We are reporting very early results from the MIZ field campaign. As such there is much yet to learn about the marginal ice zone and its acoustic environment. Using both Seaglider conductivity and temperature data and similar data from icetethered profilers deployed as part of the MIZ field campaign, we can better estimate the sound speed profile in the marginal ice zone. This will enable us to better characterize the average sound velocity, the effects of ray-bending, and how best to estimate these onboard the AUG in real-time for more accurate range estimates. For the navigation algorithm, we intend to investigate the usefulness of including a clock offset for individual sources within the filter to improve performance. In addition, we look forward to continuing to develop and test the capability of estimating average currents subsea from range measurements.

## ACKNOWLEDGMENTS

The development of ice-capable Seagliders and on-going operations in Davis Strait, and the MIZ program were made possible with the help of Geoff Shilling, Luc Rainville, Beth Curry, Adam Huxtable, Ben Jokinen, Keith Van Thiel, Eric Boget, Kunuk Lennert and the crew of F/V Nanna, Captain Sheasley and the crew of R/V Knorr, and Captain Rink and the crew of R/V Sanna. The acoustic navigation system development team at WHOI included Jim Partan, Sandipa Singh, Keenan Ball, Andrew Beal and Peter Koski.

---

All rights reserved. Reprinted with permission, from S.E. Webster, L.E. Freitag, C.M. Lee and J.I. Gobat, "Towards real-time under-ice acoustic navigation at mesoscale ranges," 2015 IEEE International Conference on Robotics and Automation (ICRA), Seattle, Washington, 2015, pp. 537-544. ©2015 IEEE DOI: 10.1109/ICRA.2015.7139231

## REFERENCES

- [1] R. Francois and W. Nodland, "Unmanned Arctic research submersible (UARS) system development and test report." APL-UW, Washington, Report 7219:87, 1972.
- [2] "Study of Environmental Arctic Change (SEARCH), 2005: Study of Environmental Arctic Change: Plans for implementation during the International Polar Year and beyond." Fairbanks, Alaska, 2005, pp. 104. [Online]. Available: [http://www.arcus.org/files/page/documents/19092/siw\\_report\\_final.pdf](http://www.arcus.org/files/page/documents/19092/siw_report_final.pdf)
- [3] "ANCHOR group, 2007. Acoustic Navigation and Communications for High-latitude Ocean Research: A Report from an International Workshop Sponsored by the National Science Foundation Office of Polar Programs," Seattle, WA, 27 February–1 March 2006, pp. 55. [Online]. Available: [http://anchor.apl.washington.edu/ANCHOR\\_workshop\\_report.pdf](http://anchor.apl.washington.edu/ANCHOR_workshop_report.pdf)
- [4] S. E. Webster, C. M. Lee, and J. I. Gobat, "Preliminary results in under-ice acoustic navigation for Seagliders in Davis Strait," in Proc. IEEE/MTS OCEANS Conf. Exhib., St. John's, Newfoundland, Sept. 2014, pp. 1–5.
- [5] T. Rossby, D. Dorson, and J. Fontaine, "The RAFOS System," *Journal of Atmospheric and Oceanic Technology*, vol. 3, pp. 672–679, 1986.
- [6] C. Jones, B. Allsup, and C. DeCollibus, "Slocum glider: Expanding our understanding of the oceans," in Proc. IEEE/MTS OCEANS Conf. Exhib., St. John's, Newfoundland, Sept. 2014, pp. 1–10.
- [7] M. Deffenbaugh, H. Schmidt, and J. Bellingham, "Acoustic navigation or Arctic under-ice AUV missions," in Proc. IEEE/MTS OCEANS Conf. Exhib., vol. 1, Victoria, BC, Oct. 1993, pp. 1204–1209.
- [8] A. Kukulya, A. Plueddemann, T. Austin, R. Stokey, M. Purcell, B. Allen, R. Littlefield, L. Freitag, P. Koski, E. Gallimore, J. Kemp, K. Newhall, and J. Pietro, "Under-ice operations with a REMUS-100 AUV in the Arctic," in IEEE/OES Auto. Und. Veh. (AUV), Sept. 2010, pp. 1–8.
- [9] M. V. Jakuba, C. N. Roman, H. Singh, C. Murphy, C. Kunz, C. Willis, T. Sato, and R. A. Sohn, "Long-baseline acoustic navigation for under-ice autonomous underwater vehicle operations." *J. Field Rob.*, vol. 25, pp. 861–879, 2008.
- [10] M. Hildebrandt, J. Albiez, M. Fritsche, J. Hilljegerdes, P. Kloss, M. Wirtz, and F. Kirchner, "Design of an autonomous under-ice exploration system," in Proc. IEEE/MTS OCEANS Conf. Exhib., San Diego, CA, Sept. 2013, pp. 1–6.
- [11] O. Hegrenæs, K. Gade, O. Hagen, and P. Hagen, "Underwater transponder positioning and navigation of autonomous underwater vehicles," in Proc. IEEE/MTS OCEANS Conf. Exhib., Biloxi, MS, Oct. 2009, pp. 1–7.
- [12] C. Kaminski, T. Crees, J. Ferguson, A. Forrest, J. Williams, D. Hopkin, and G. Heard, "12 days under ice — an historic AUV deployment in the Canadian High Arctic," in IEEE/OES Auto. Und. Veh. (AUV), Sept. 2010, pp. 1–11.
- [13] M. Doble, P. Wadhams, A. Forrest, and B. Laval, "Experiences from two-years' through-ice AUV deployments in the High Arctic," in IEEE/OES Auto. Und. Veh. (AUV), Oct. 2008, pp. 1–7.
- [14] C. Lee, S. Cole, M. Doble, L. Freitag, P. Hwang, S. Jayne, M. Jeffries, R. Krishfield, T. Maksym, W. Maslowski, B. Owens, P. Posey, L. Rainville, B. Shaw, T. Stanton, J. Thomson, M.-L. Timmermans, J. Toole, P. Wadhams, J. Wilkinson, and Z. Zhang, "Marginal ice zone (miz) program: Science and experiment plan," Applied Physics Laboratory, University of Washington, Seattle, WA, Technical Report APL-UW 1201, September 2012, 48 pp.
- [15] S. E. Webster, R. M. Eustice, H. Singh, and L. L. Whitcomb, "Advances in single-beacon one-way-travel-time acoustic navigation for underwater vehicles," *Intl. J. Robot. Res.*, vol. 31, no. 8, pp. 935–950, July 2012.
- [16] J. M. Walls and R. M. Eustice, "An origin state method for communication constrained cooperative localization with robustness to packet loss," *Intl. J. Robot. Res.*, vol. 33, no. 9, pp. 1191–1208, 2014.
- [17] A. Bahr, M. Walter, and J. Leonard, "Consistent cooperative localization," in Proc. IEEE Intl. Conf. Robot. Auto. (ICRA), Kobe, Japan, May 2009, pp. 3415–3422.
- [18] M. F. Fallon, G. Papadopoulos, J. J. Leonard, and N. M. Patrikalakis, "Cooperative AUV navigation using a single maneuvering surface craft," *Intl. J. Robot. Res.*, vol. 29, no. 12, pp. 1461–1474, Oct. 2010.
- [19] J. Vaganay, J. Leonard, J. Curcio, and J. Willcox, "Experimental validation of the moving long base-line navigation concept," in IEEE/OES Auto. Und. Veh. (AUV), June 2004, pp. 59–65.
- [20] L. Freitag, M. Grund, S. Singh, J. Partan, P. Koski, and K. Ball, "The WHOI Micro-Modem: an acoustic communications and navigation system for multiple platforms," in Proc. IEEE/MTS OCEANS Conf. Exhib., Washington, D.C., Sept. 2005, pp. 1086–1092.
- [21] E. Gallimore, J. Partan, I. Vaughn, S. Singh, J. Shusta, and L. Freitag, "The WHOI Micro-Modem-2: A scalable system for acoustic communications and networking," in Proc. IEEE/MTS OCEANS Conf. Exhib., Seattle, WA, Sept. 2010, pp. 1–7.
- [22] S. Singh, M. Grund, B. Bingham, R. M. Eustice, H. Singh, and L. Freitag, "Underwater acoustic navigation with the WHOI Micro-Modem," in Proc. IEEE/MTS OCEANS Conf. Exhib., Boston, MA, Sept. 2006, pp. 1–4.
- [23] C. C. Eriksen, T. J. Osse, R. D. Light, T. Wen, T. W. Lehman, P. L. Sabin, J. W. Ballard, and A. M. Chiodi, "Seaglider: A long-range autonomous underwater vehicle for oceanographic research," *IEEE J. Oceanic Eng.*, vol. 26, pp. 424–436, Oct. 2001.
- [24] J. M. Walls and R. M. Eustice, "Experimental comparison of synchronous-clock cooperative acoustic navigation algorithms," in Proc. IEEE/MTS OCEANS Conf. Exhib., Kona, HI, Sept. 2011, pp. 1–7.
- [25] S. T. Cole, M.-L. Timmermans, J. M. Toole, R. A. Krishfield, and F. T. Thwaites, "Ekman veering, internal waves, and turbulence observed under arctic sea ice," *J. Phys. Oceanogr.*, vol. 44, pp. 1306–1328, 2014.

